



# Laser Target-Shooting

EEL 4915 Senior Design II  
Spring 2023

## Group 6

Cameron Vo	Optical Engineer
David Johnson	Electrical Engineer
Eltholad Orelie	Electrical Engineer
Quang Pham	Computer Engineer

# Table of Contents

- 1.0 Executive Summary ..... 1
- 2.0 Project Motivation..... 1
  - 2.1 Goals ..... 2
  - 2.2 Objectives ..... 3
  - 2.3 Requirements/Specifications ..... 7
  - 2.4 House of Quality ..... 8
- 3.0 Project Research..... 9
  - 3.1 Similar Products and Past Projects ..... 10
  - 3.2 Part Selection ..... 11
    - 3.2.1 Wavelength Selection ..... 11
    - 3.2.2 Laser Diodes ..... 13
    - 3.2.3 Target Board Material ..... 14
    - 3.2.4 Photodetectors ..... 15
    - 3.2.5 LEDs ..... 16
    - 3.2.6 Beam Splitter ..... 18
    - 3.2.7 CMOS Camera and LCD Display ..... 18
    - 3.2.8 Audio Amplifier ..... 19
    - 3.2.9 Speakers ..... 20
    - 3.2.10 Vibrational Feedback ..... 20
  - 3.4 Processor Research ..... 22
    - 3.4.1 Choosing Between Bluetooth and Wi-Fi ..... 25
    - 3.4.2 MCU Technology and Specifications ..... 26
    - 3.4.3 Arduino Mega 2560 vs. MSP-EXP430G2ET vs. ESP32-WROOM-32D-N4 .. 26
    - 3.4.4 Development Board ..... 28
  - 3.5 Power Research ..... 28

3.5.1 Sources and Regulation.....	28
3.5.2 Battery Technology .....	29
3.5.3 Charging Technology.....	30
3.5.4 Voltage Regulators .....	31
3.5.5 MOSFETS.....	33
3.5.6 OP AMPS.....	34
3.5.7 Battery Power Conclusion.....	35
3.5.8 Voltage Regulator Conclusion .....	35
4.0 Related Standards and Design Constraints .....	36
4.1 Standards .....	37
4.1.1 Hardware Soldering Standards.....	37
4.1.2 PCB Standards .....	39
4.1.3 Charging Standard.....	40
4.1.4 Coding Standard - Programming Standard.....	41
4.1.5 Documentation Standard .....	42
4.2 Constraints .....	43
4.2.1 Laser Safety Constraints.....	43
4.2.2 Sustainability Constraints.....	44
4.2.3 Social, Ethical, and Environmental Constraints .....	44
4.2.4 FCC Regulation - CFR 47 Part 15 - Radio Wave Constraints .....	44
4.2.5 Manufacturing Constraints .....	45
4.2.6 Time Constraints.....	46
4.2.7 Economic Constraints .....	46
5.0 Project Hardware and Software Design Details .....	46
5.1 Hardware: Optical Designs .....	46
5.1.1 Beam Collimator .....	47
5.1.2 Beam Expander .....	47

5.1.3 Target Board Lens System .....	49
5.1.4 Variable Power Rifle Scope .....	52
5.1.5 CMOS Camera Lens System.....	60
5.1.6 Variable Focus IR Flashlight .....	63
5.1.7 Stretch Designs: Safety Camera and Other Rifle Optics .....	65
5.2 Hardware: Electrical Designs .....	67
5.2.1 Audio System.....	68
5.2.2 Laser Driver Circuit .....	70
5.2.3 Vibration Motor Circuit .....	72
5.2.4 Target Board IR Receiver Circuit .....	72
5.2.5 IR Flashlight Circuit.....	73
5.2.6 Power Design.....	74
5.2.7 Battery Life Indication .....	76
5.2.8 PCB Manufacturer and Design .....	77
5.3 Software .....	78
5.3.1 Software Overview.....	78
5.3.2 Software Design Tools .....	79
5.3.3 Use Case of the System .....	81
5.3.4 PCB Design Software .....	82
5.3.5 Summary of PCB Design Software.....	85
6.0 Prototype Construction and Operations .....	86
6.1 Laser Rifle Assembly.....	86
6.1.1 Rifle Attachments.....	86
6.2 Target Board Assembly .....	89
6.3 User's Manual.....	90
6.3.1 User's Manual For Rifle Attachments .....	94
7.0 Prototype Testing .....	94



7.1 Hardware Testing Environment .....	94
7.2 Hardware Testing .....	95
7.2.1 PETG Lens Testing.....	95
7.2.2 Laser Diode Testing.....	97
7.2.3 Visible LED Testing.....	98
7.2.4 IR Receiver Testing .....	98
7.2.5 Rifle Scope Testing.....	98
7.2.6 CMOS Camera and IR Flashlight Testing.....	102
7.2.7 Audio Testing .....	105
7.2.8 Wireless Communication Testing .....	106
7.2.9 Unit Testing.....	106
7.2.10 Pairing Testing .....	106
7.2.11 Energy Testing.....	107
7.2.12 Uptime Testing.....	107
7.2.13 Range and Angle Testing .....	107
7.3 Software Prototype .....	108
7.3.1 User Interfaces Design .....	108
7.3.2 System Features Design.....	113
8.0 Administrative Content .....	114
8.1 Bill of Materials .....	115
8.2 Scheduling and Milestones.....	116
9. Summary.....	119
9.1 Project Summary .....	119
9.2 Future Improvements .....	119
9.3 Concluding Thoughts.....	120
Appendices .....	121
Appendix A: References .....	121

# List of Figures

- Figure 1. Full System Interaction Between Target and Rifle ..... 5
- Figure 2. System Interaction Front Plane..... 6
- Figure 3. System Interaction Cross Section ..... 6
- Figure 4. House of Quality ..... 9
- Figure 5. Solar Spectrum ..... 12
- Figure 6. Generic Silicon Photodiode Spectrum ..... 13
- Figure 7. Voltage Rail Description..... 36
- Figure 8. Keplerian and Galilean Beam Expander ..... 48
- Figure 9. Diffuser and Concave Lens Proof of Concept..... 50
- Figure 10. 50mm Diameter Plano Concave Lens 3D Model ..... 51
- Figure 11. 50mm Diameter PETG Lens Diagram ..... 52
- Figure 12. Parallax Error ..... 54
- Figure 13. Rifle Scope Lens Layout ..... 57
- Figure 14. Rifle Scope Aberrations Chart ..... 59
- Figure 15. MTF of Rifle Scope ..... 60
- Figure 16. Camera-Scope System Layout..... 61
- Figure 17. Camera Lens System Aberrations ..... 63
- Figure 18. IR Flashlight Lens Layout ..... 65
- Figure 19. Sensor Field of View Concept..... 66
- Figure 20. Reflex Sight Diagram ..... 67
- Figure 21. Hardware Block Diagram ..... 67
- Figure 22. Prototype Operations Block Diagram..... 68
- Figure 23. Audio Amplifier and Speaker Connector ..... 70
- Figure 24. Laser Driver w/ BJT ..... 71
- Figure 26. Vibrational Motor ..... 72

Figure 27. IR Receiver Schematics.....	73
Figure 28. IR Flashlight Circuit.....	74
Figure 29. Power System Design Rifle and Battery .....	75
Figure 30. 3.3V regulator .....	75
Figure 31. 5V regulator .....	76
Figure 32. Mobile Phone Application Block Diagram .....	79
Figure 33. Laser Target Shooting System Use Case.....	82
Figure 34. Component Placement in Rifle .....	86
Figure 35. Reflex Sight 3D Model .....	87
Figure 36. Rifle Scope Solidworks Model and Mounted .....	88
Figure 37. Target Board Lid Off and On.....	90
Figure 38 - Device Paired Page .....	91
Figure 39. Two Devices Paired Page.....	92
Figure 40. Two Devices Configuration Page.....	93
Figure 41. Surface of Unprocessed vs Processed Lens .....	96
Figure 42. PETG 40mm EFL Plano Convex Lens Testing.....	96
Figure 43. PETG 60mm EFL Plano Concave Lens Testing.....	97
Figure 44. Printed 1951 USAF Resolution Test Chart .....	99
Figure 45. Scope Resolution vs. Lighting Test.....	100
Figure 46. Scope FOV Testing with Ruler.....	101
Figure 47. Magnification vs Erector Assembly Displacement .....	102
Figure 48. Rifle Scope with Camera and Lens System.....	103
Figure 49. Camera FOV Lens System Testing .....	104
Figure 50. Camera-Scope Night Vision Testing.....	105
Figure 51. Find Device Page.....	108
Figure 52. Gun Page Information .....	109
Figure 53. Target Board Information .....	110

Figure 54: User Interface of Each Game Mode in the Play State .....	112
Figure 55: User Interface for Game Exit in the Play State .....	113
Figure 56. Laser Rifle and Target Board MCU State Machine Diagram .....	114

# List of Tables

Table 1: System Requirements .....	8
Table 2: Microcontroller Comparison .....	28
Table 3. Comparison of Batteries.....	30
Table 4. Voltage Regulator Comparison .....	33
Table 5. 50mm Diameter PETG Lens Data .....	52
Table 6. Rifle Scope Lens Data .....	56
Table 7. Camera-Scope System Lens Data.....	62
Table 8. IR Flashlight Lens Data .....	64
Table 9. PCB Manufacturer Comparison .....	78
Table 10. Bill of Materials .....	115
Table 11. Fall 2022 Project Milestones .....	117
Table 12. Spring 2023 Project Milestones .....	118

# 1.0 Executive Summary

Recreational shooting is a pastime that gun owners do to sharpen their shooting skills or do simply for fun. However, most people do not have the luxury of being able to shoot a firearm near their home and must go to a local shooting range for practice. At shooting ranges, for people who do not bring their own equipment and must rent, prices can easily get up to a hundred dollars per hour. Unequipped visitors not only have to rent expensive ear and eye protection, shooting lanes, and guns but must also purchase the ammunition being used in their firearm of choice. Renting a fully automatic firearm from some firing ranges can be as high as three times the price of renting a standard semi-automatic pistol. For visiting gun owners, they must drive to their local range, bring their equipment, and rent a shooting lane. Overall, this process can be very inconvenient.

There are alternatives to firing ranges such as using Airsoft guns or living in areas where firearms can be fired in backyards, but these solutions involve firing lead and plastic rounds outside which can have negative effects on the environment or can cause accidental injuries or property damage if no precautions are taken. Regarding Airsoft in particular, firing these weapons are much safer than firing real firearms; however, the lack of recoil and the lack of power in the BB pellets fired makes for an unrealistic and unsatisfying shooting experience.

This project aims to remove the disadvantages of using a live firearm while remaining as a realistic, but safe, way to train yourself to handle firearms. This was accomplished by replacing the ballistic ammunition used in a traditional firearm with infrared lasers. This laser rifle was paired with a target board, a large but portable 3D printed board containing IR receivers that responds to the infrared laser and provides visible feedback to one's shot placement. This project also contains other features not seen in traditional shooting ranges such as keeping scores for accuracy-based game modes and a versatile gun that can change firing characteristics such as recoil pattern with the press of a button on our smartphone app.

Naturally, we are not the first to come up with this idea. There are various market products being sold with the same premise and even Senior Design students at UCF have done similar projects in the past. As such, our goal is to make a product that excels over others in all fields such as safety and customization. With market prices ranging from a hundred dollars to over five hundred dollars for similar products, our project aims to work as well as high-end market products while improving by adding various features and keeping costs low. As designed, the prototype contains a realistic, highly portable rifle and target board pair that can be used in any lighting condition, be it noon or midnight. The Laser Rifle firing system is strictly controlled such that laser safety regulations are followed.

## 2.0 Project Motivation

Going to a shooting range is not something that everyone is able to spend their time or money on. Our project aims to bring the firing range experience to your home by creating a laser rifle and an electronic target board. The target board will light up whenever the

laser rifle is used to shoot at the target board. The target and rifle system will be connected using a smartphone app to play a variety of games and manage their settings. By using lasers, the downsides of traditional target shooting such as danger, environmental impact, and high cost are improved upon, while portability and accessibility is increased. Our project is intended to be a way to entertain yourself as well as function as an educational firearm safety training tool for people who are concerned about handling live firearms. Compared to market products, our project aims to be fully functioning in any lighting environment (day or night) and involves the development of a mountable rifle scope compatible with our custom night vision system. We also aim for customizability by using the smartphone app to change features such as the rifle's rate of fire and gunfire sound.

## **2.1 Goals**

### **Core Goals**

At its foundation, our project requires the use of a rifle that fires an infrared laser beam out of the barrel. This laser rifle is used to strike a target board that reacts to the beam and lights up an area where the beam strikes the surface of the board. Without this fundamental setup, the system will not work. Another one of our core goals is to make a laser target-shooting system that is an overall improvement on market products. As most people go to firing ranges for entertainment and training for firearm handling, our project also keeps these core goals in mind when deciding project features, which are related to our advance and stretch goals.

For our advance goals, we view these goals as our project features that supplement our core project to become a product that excels over others. Our project aims to make a laser rifle and target board that has a plethora of features that prioritize customization, safety, and user convenience. Both the laser rifle and target board are designed to be highly portable devices that are usable in any lighting environment ranging from broad daylight to pitch black midnight. For nighttime, this is possible through the employment of a mountable night vision camera scope system paired with an infrared flashlight.

Additionally, the camera is removable, allowing the rifle scope to be used by itself for firearm training using gun optics. To deal with broad daylight, our system uses IR receivers, modified photodiodes that react only to light modulating at a specific frequency, in order to prevent unwanted light sources from activating the target board. The target board also includes some measures to deal with these unwanted light sources. This includes an “inherent lens system” that reduces the amount of light reaching the IR receivers, essentially allowing only the powerful IR laser light to be detected.

The laser rifle also needed to be highly customizable and user convenient. This is why we decided to develop a custom smartphone app that controls every aspect we want to change. We included options to play different gunfire sounds, change the amount of recoil, and control the amount of ammo the rifle has by using this smartphone app. The smartphone app connects between the target board and rifle wirelessly, allowing score to be kept track through the app.

## **Stretch Goals**

Ideally, we would like to have as many features as possible. Given the number of resources, components, and other features that we need to work on, many of these features will unfortunately be considered last priority. The features we would have liked to add but were unable to be included in our final design are: ability to switch firing mode (semi auto, burst, automatic, & spread), different game modes to be added within the phone application, ability to cycle through games with display on gun, ability to modify recoil intensity to simulate different gun variants, remaining ammo capacity on the gun display, infrared sensors determining shot distance, variable laser spot size, dual laser system with visible laser and IR laser, and other types of optics such as a red dot sight or holographic sight. This would make our rifle much completer and more versatile as a product and as a tool for entertainment and training.

Another stretch goal that we considered as interesting but difficult to implement was a human detection safety system. Using a specialized camera that would be mounted directly to the rifle, the camera would provide a live video feed to a computer that would be processed using artificial-intelligence-based face or human body detection algorithms. When a person is detected in the field of view of the camera, the laser would be forced to shut off as a safety measure.

This was considered a stretch goal because this would require a large amount of processing power that would be difficult to install when using a highly mobile platform. Additionally, unlike security camera systems that typically use these detection algorithms, the rifle is constantly moving around. As a result, the performance of the algorithm would suffer due to the constant movement and could very likely fail to process the information fast enough to act as an effective safety measure. This is a major issue as safety is one of our main priorities when designing the project.

## **2.2 Objectives**

The rifle frame was a modified version of the AR-15 with a realistic feel and look. Utilizing rechargeable batteries as a power source, the rifle was portable while having a weight similar to that of a real firearm. The laser rifle featured a 940 nm wavelength laser used for signal transmission to the target board. The IR laser acts as a transmitter and is modulated at a 38 kHz carrier frequency that IR receivers in the target board will be able to react to. The light emitted from the laser diode interacted with a beam expander before exiting the rifle system.

The laser rifle was programmed so that gunfire sounds would be able to play and recoil-simulating vibration motors activated when fired. The rifle had a software-based magazine system and ammo counter that required magazines to be changed after depleting all rounds in the magazine. All features were customizable using a smartphone app that communicates with the rifle using Bluetooth.



The main attachment for the laser rifle is a night vision system using a magnified scope, LCD display, and camera. First, a rail-mounted optical rifle scope that can be used to magnify and view the target was designed and made. The rifle scope contained a telescoping magnification system for variable zoom. A camera using an IR compatible CMOS sensor was then mounted such that it is effectively looking through the scope like a human eye. The camera was also removable, so the scope can be used to aim as a normal optical sight. A separate lens system was made for the camera to set a desired field of view.

The camera was hooked up to an LCD display mounted to the scope that plays live feed from the camera-scope system. Using a custom LED flashlight with a 860 nm peak wavelength, the surrounding area was illuminated with IR light that was captured by the camera and streamed onto the display. Since the amount of IR light necessary to have a clear image varied with distance, the flashlight also included a telescoping lens system to change the intensity of the light. The role of the telescoping flashlight is to be able to change the spread of the light outputted by the flashlight so that most of the light is incident on the target board rather than being wasted by spreading around it. This allows more of the IR light to reflect and return to the CMOS camera for a higher quality image.

Ultimately, this system can be used to view the target and fire at it by using the display to aim. This makes it possible to use our target-shooting system in low-light environments where photodetectors will work best due to low optical noise from other light sources. Of course, a simple white light flashlight could be attached to the rifle, but using this night vision system makes it possible to use the rifle to simulate night vision training scenarios where flashlights cannot be used.

We have developed a series of Solidworks 3D model diagrams to show conceptually how all of the parts of our system worked. In **Figure 1**, we show how all of these components interact conceptually. Scorekeeping was controlled using a smartphone app connecting to the target board using Bluetooth. Using rechargeable batteries as a power source, the target board gave visible feedback to where the laser was fired at using LEDs and IR receivers.

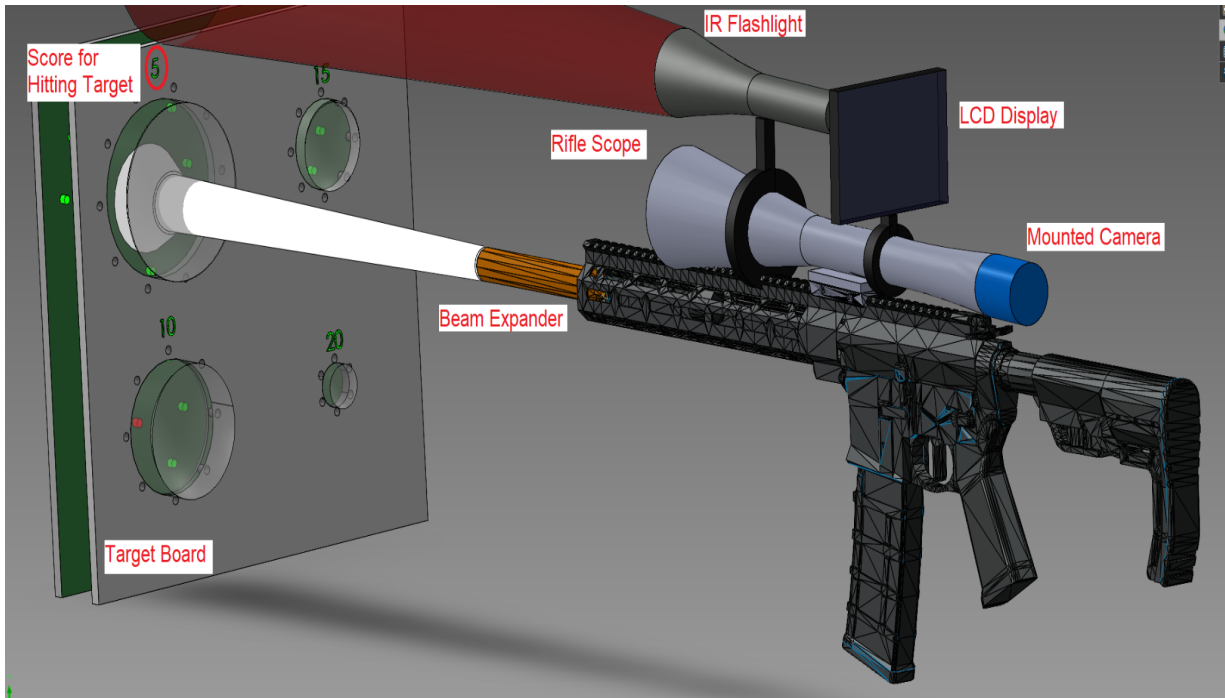

**Figure 1. Full System Interaction Between Target and Rifle**

Receivers were chosen over standard photodiodes and phototransistors because they are more resistant against ambient IR lighting (1), ideally allowing the target-shooting system to be used in broad daylight. The IR receivers, placed in the center of a target circle, will be used to detect where the shot was placed and cause the surrounding LEDs to light up. This concept is shown in **Figure 2**, which is a front view of the interaction between the target board and laser rifle. In this figure, the laser is fired into the target area marked “5” and the LEDs light up in response, while the target area marked “10” remains off since no laser is detected.

In **Figure 3**, a cross section of the interaction between the laser rifle and target board is shown. The LEDs and receivers were installed behind the front surface of the target board. There were designated holes in the front surface of the board where the LEDs emitted visible light that the user would be able to see after hitting one of the receivers in an area. Unlike the LEDs, the tops of the receivers were completely behind the target board with no holes present. Note that you can see the IR receiver in **Figure 2** despite the image looking from the front plane because the receivers are mounted behind transparent concave lenses that are used to expand the laser beam for more reliable laser detection as well as protect the receivers from being exposed to the elements.

### **Update**

The target board design used in the figures are outdated but are good for illustrating how the system works so they were kept. More information about changes related to the target board will be provided in other sections. We also originally wanted to include a dual laser

system with IR and a visible laser, but in the integration phase this idea had to be completely scrapped due to spatial limitations; we removed it from our objectives. However, we still include information about it in other sections such as our House of Quality since we did design for it and bought the components necessary to implement it.

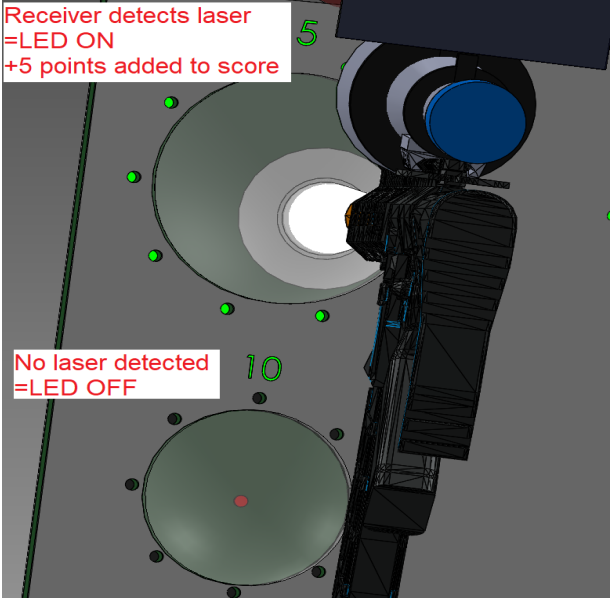

Figure 2. System Interaction Front Plane

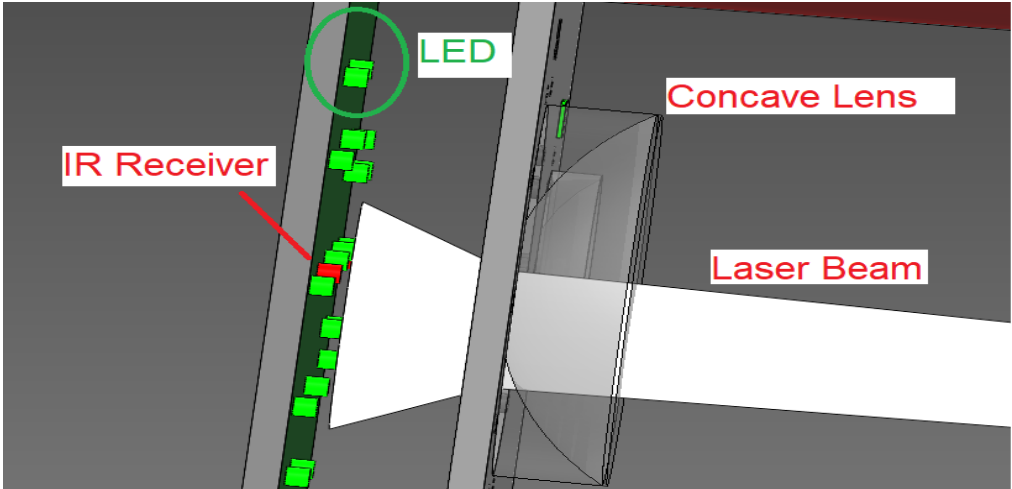

Figure 3. System Interaction Cross Section

## 2.3 Requirements/Specifications

In **Table 1**, the various system requirements for our project are listed. These requirements were decided based on what we thought were reasonable, as well as based on some real-world applications. For example, the “long range” distance was determined as 15m because real firearms are universally made and calibrated for usage at 25 yards. We chose 15m because 25 yards is a very large distance, meaning that it would be difficult to test the laser indoors. For the target board size, we decided these parameters based on what kinds of target boards other market products were using.

Requirement ID	Requirement/Specification	
1.0	The system will not exceed 10 lbs. with all internal components.	5 - 10 pounds
1.1	The system will be pairable with a phone through Bluetooth and be recognized by the mobile app.	Bluetooth 5.0
1.2	The system will be powered by batteries that can be recharged with a compatible plug.	9V Lithium Battery
1.3	The system needs to perform at the shortest time interval between the pulling of the trigger and the visual response of the target.	< 1 second
1.4	The system idle power should be low.	Rifle- 1Wh Target- 0.5Wh
1.5	The system should be in “ready for use” state within a short time after startup.	< 1 minute
1.6	The system should have the controller stay running at a high uptime.	> 4 hours
1.7	The system should operate without overheating.	< 50 °C
1.8	The system will include a mountable rifle scope with high resolving power	> 3.5x magnification <0.15 mrad angular resolution
1.9	The system will be able to operate at a long distance between the rifle and target board.	>15m

1.10	The system will emit a laser beam that has low divergence such that it can be used accurately at long ranges.	<1.5 mm per meter (1.5 mrad)
1.11	The system will output a laser spot size that is small enough to ensure accurate shot placement on the target board.	<40 mm at 15m target distance
1.12	The system will emit a laser beam that is considered low risk for eye safety.	Class 3R (<5 mW)
1.13	The system will use a 3D printed target board that is large enough to be clearly visible at long ranges while also being portable	>200mm x 200mm < 10 lbs

**Table 1: System Requirements**

## 2.4 House of Quality

In **Figure 4**, our house of quality is shown. The house of quality was made for an analysis of the different design requirements that we have decided in our project and how these relate to the overall market requirements for these kinds of products. Our house of quality is centered around marketing towards the military simulation market. Military simulation gear is typically military gear designed to be as realistic to military standard gear while being safe and legal for normal citizens to own.

The reason why we mention this is because laser guns can be marketed to different audiences. Airsoft, for example, tends to have highly realistic BB guns and can be mistaken for a real firearm by someone who is not accustomed to seeing or handling this kind of equipment. On the other hand, laser tag guns are made as a toy for entertainment and are naturally not designed to look like real firearms. As a result, most of our requirements are going to be marketing towards the military simulation audience and this is reflected in our house of quality.

Additionally, the house of quality is important in the design process as they are used to compare the different requirements we have set and show how they relate to each other in a positive or negative way. For example, our house of quality contains design requirements regarding the rifle weight, cost, and target board size. All these elements have a positive relationship because increasing the rifle weight and the size of the target board will cost more due to using more and/or heavier materials to construct these parts.

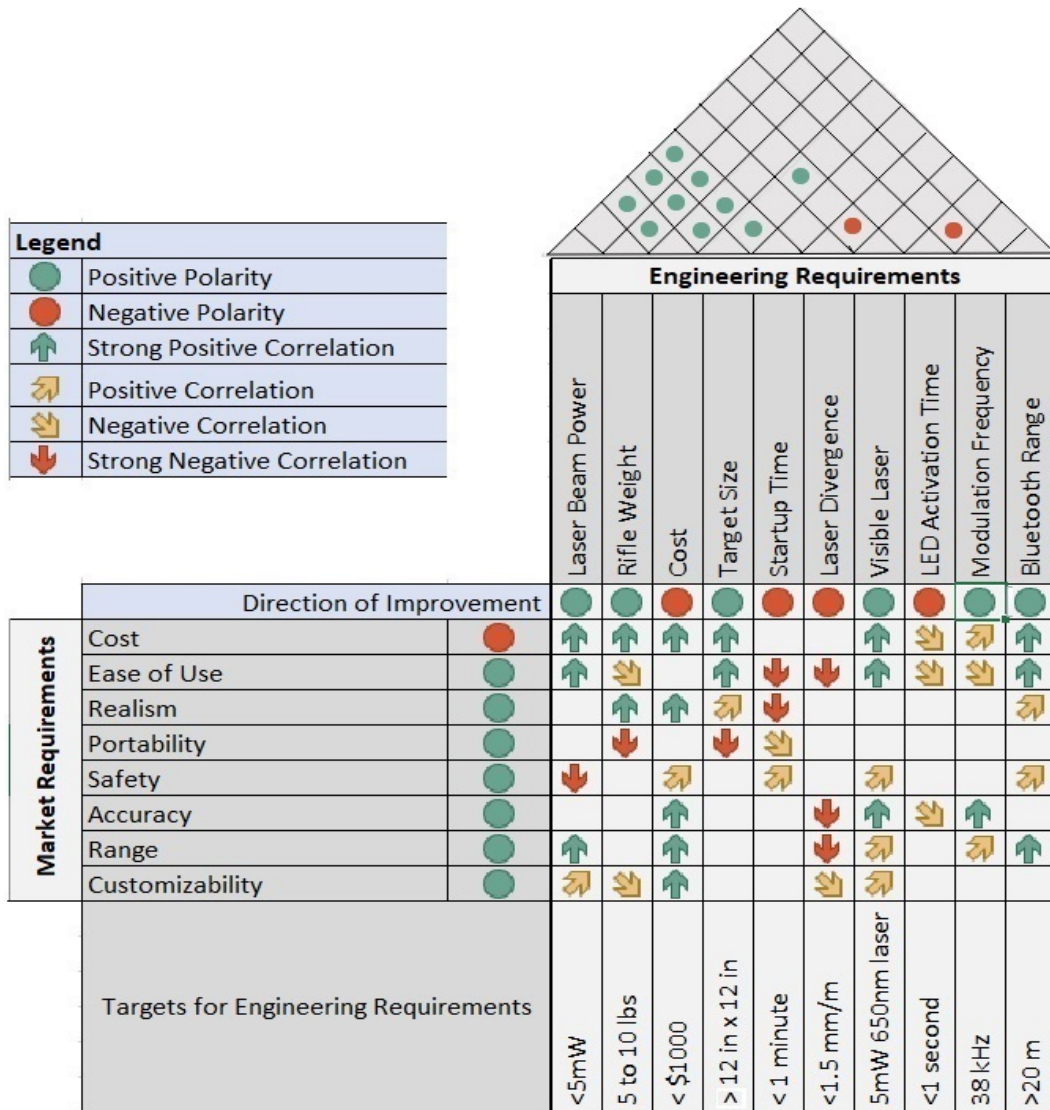

Figure 4. House of Quality

### 3.0 Project Research

In this section we will describe the research done by each of the team members. This research includes comparing and selecting the optimal parts for the project as well as evaluating previous project designs for further inspiration and improvement. Performing this research is essential in the design of the Laser Target-Shooting project. Researching previous and/or similar designs will allow us to take note of what went wrong in prior projects to allow for improvements in our own design and implementation. This section will cover existing products, relevant technology, the system architecture, and part selection relevant to the design of our Laser Target-Shooting project.



## 3.1 Similar Products and Past Projects

While our project idea is not new in the market, our project also aims to improve on other products in terms of realism, safety, and convenience. With similar products prices going from \$100 to over \$500 for laser training systems, features vary heavily.

The cheapest systems include ones such as the Strikeman Training System (2) and LaserHIT (3) that involve using \$40+ battery-powered “laser cartridges” that are placed into real firearms and fire visible light lasers when the trigger is pulled. These systems use custom software, such as an app using a phone camera, that tracks the location of where a shot is made on a physical target. The laser detection on the target seems to be done through a camera-based algorithm using a laser triangulation system. The laser light reflecting off the target is analyzed to find the position of the shot on the target.

These systems are typically around \$100 or more for physical components and the software is typically free. Since real firearms are being used, these systems are realistic in the handling and aiming aspect, but since no actual rounds are being fired, there are no shooting elements like recoil or even gunshot sounds. Pulling the trigger is no different from pressing a button on a TV remote. Every shot fired requires the round to be rechambered using the slide on a pistol or the pump on a shotgun, so no full auto is possible using these systems.

Larger scale systems such as Laser Shot (4) provide training to military and police personnel. While offering their own simulation systems, prices are extraordinary at over \$500 for the cheapest laser weapons they have to offer. Their laser weapons come with recoil simulating CO2 canisters like those used in Airsoft guns and have the option to either be visible or IR light. Gunshot sounds play when weapons are fired.

These systems are typically used with simulation software that connects to large projectors where users can play various types of aiming training games. The laser detection systems seem to work on the same laser triangulation system described above and requires special camera equipment. They have many features that try to simulate real firearms at the cost of low portability as they are designed to be stationary.

Finally, systems like LaserLyte (5) provide a different approach to the laser cartridge systems at around \$150 for a pistol and \$200 for a physical target board. These systems typically use pistols with visible laser diodes installed into them. The pistols are typically aimed at physical, electronic targets that play sounds and light up LEDs when fired at. Unlike the other two approaches described above, the laser detection system used in these target boards are some kind of photo detector such as photodiodes or phototransistors.

Overall, these share the same flaws as laser cartridge systems and are fundamentally gun-shaped laser pointers. Compared to the more expensive systems, these are the most portable systems, but the targets used are typically very small. More expensive target boards have precise tracking that counts score depending on where a shot was made like in darts. These systems are the least realistic in all aspects but are highly portable.

In past UCF Senior Design projects, there are three main ones that we have used for reference. These include the Wirelessly Connected Laser Shooting Gallery from Spring 2022, the Laser Target Gallery from Fall 2019, and the Laser Skeet from Spring 2018. Across all these projects, several approaches to communicate between the target board and gun were made including Bluetooth and RF. We took interest in Laser Skeet (6) since our team composition was the same (two EE, one CPE, one optics) and our projects are quite similar.

In their project, they used a 980 nm IR laser beam modulated at 30 kHz. Phototransistors inside of their skeet target were used to capture the modulated light and light up the target and play speakers upon hitting the target. Their target design, which is designed at accurate skeet target dimensions, initially considered a Fresnel lens design for coupling light, but they report that it was not worth the cost and would increase optical noise. From a thorough reading of their project report, we can make more informed decisions regarding our project.

## 3.2 Part Selection

### 3.2.1 Wavelength Selection

First, it is important to discuss the wavelength used in our system. The main issues regarding wavelength relate to cost, safety, and optical noise. Since the power level used in our laser rifle will not be able to harm a person aside from their eyes, it is only necessary to discuss laser eye safety. The wavelength also relates to which part of the eye the laser will focus onto. Since the eye acts like a lens, different wavelengths will focus onto different parts of the eye. As a result, wavelengths above 1400 nm (7) are generally considered to be eye-safe wavelengths and will not cause eye damage unless they are at extremely high powers.

The safety of the laser also relates to the visibility of the light. Some lasers are only considered “eye-safe” because they are visible. This is because when the intensity of light is too high, humans subconsciously close their eyes and block the incoming light before any damage can happen (8). However, if you are using a non-visible beam, this response will not happen, and you could potentially be staring at a laser without even knowing. Even a low power laser could cause eye damage if you stare into the beam for a long period of time.

Additionally, optical noise is related to the detection of the IR receivers. Most photodetectors have a large optical spectrum that are centralized around a peak wavelength, so noise may be of a concern depending on the wavelength. To determine what wavelength would experience the least optical noise, we referenced the optical spectrum of the sun in **Figure 5** (9). Based on the solar spectrum chart and previously discussed laser eye safety guidelines, one may think that it would be best to use a wavelength that is greater than 1400 nm due to the extremely low optical noise and inability to cause eye damage. However, when we researched for parts, we noticed that it is very difficult to find laser diodes that are made for these wavelengths. If they are



available, they are usually at extremely high powers in the watt range. Naturally, these diodes are far more expensive.

In contrast, 940 nm diodes are more common and come at much more reasonable prices with a good variety of optical powers. We ultimately decided on the 940 nm wavelength despite being a potentially harmful NIR wavelength. Based on the solar spectrum, it is clear to see that the amount of optical noise caused by sunlight will be very low at 940 nm compared to other wavelengths. In fact, this is why many systems such as TV remotes use 940 nm LEDs that modulate at high frequencies. Light modulated at high frequencies is not present in light coming from the sun, so much of the optical noise is eliminated from the photodetection systems when combined with 940 nm transmitters.

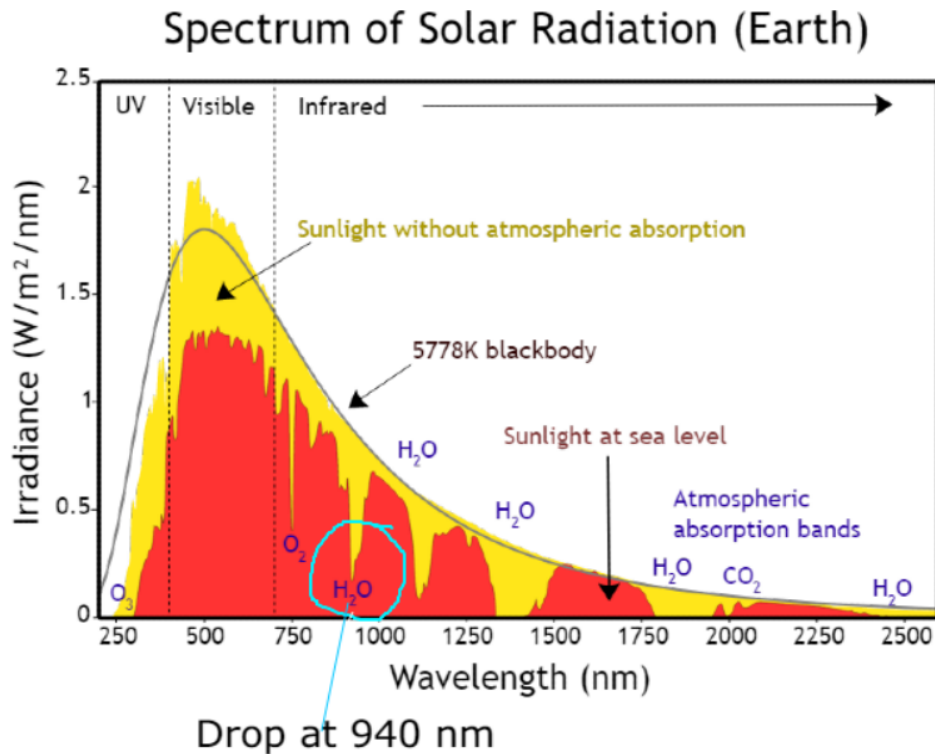

Figure 5. Solar Spectrum

Since the laser was 940 nm, for the IR flashlight, we chose to use 860 nm as the NIR light source. This is due to the quantum efficiency of CMOS and CCD sensors. A standard RGB CMOS sensor with no modifications to improve IR sensitivity has very low quantum efficiency at IR wavelengths (10). 940 nm has an extremely low quantum efficiency while 860 nm has a relatively large quantum efficiency at around 15% depending on the model used. As a result, 860 nm is quite popular and is often used in night vision systems for

security cameras. Additionally, 860 nm is a useful wavelength as it pairs well with the IR receivers. The IR receivers have a large optical spectrum, but receivers with a peak wavelength at 940 nm tend to have around 20% sensitivity at 860 nm. As a result, we do not have to worry about significant optical noise coming from the flashlight.

### 3.2.2 Laser Diodes

For our system, a laser diode is most appropriate as they are compact and come at low powers that are compatible with the laser class we needed to use in our system. However, that does not mean they do not have their disadvantages. Laser diodes have several problems including temperature dependence, high divergence angles, and becoming hot while operating.

As the laser diode increases in temperature, the wavelength of the light output by the diode increases. In many cases, this is an advantage that makes the laser diode a versatile tool. However, in the absence of a temperature controller unit, our system sees mainly disadvantages from this aspect. Since our rifle was used outdoors and the laser diode will heat itself up as the rifle is used more and more, having a temperature controller unit would be useful, but it is simply not possible given we want a highly portable setup. Even though the temperature could be an issue regarding causing damage to the diode, given the sensitivity spectrum of IR receivers, we believe that the performance of the system will not be significantly affected. Photodetectors in general have a large optical spectrum as shown in **Figure 6** (11). Even with significant temperature changes, the laser-target system will still be able to perform well unless the IR diode itself malfunctions or breaks due to overheating.

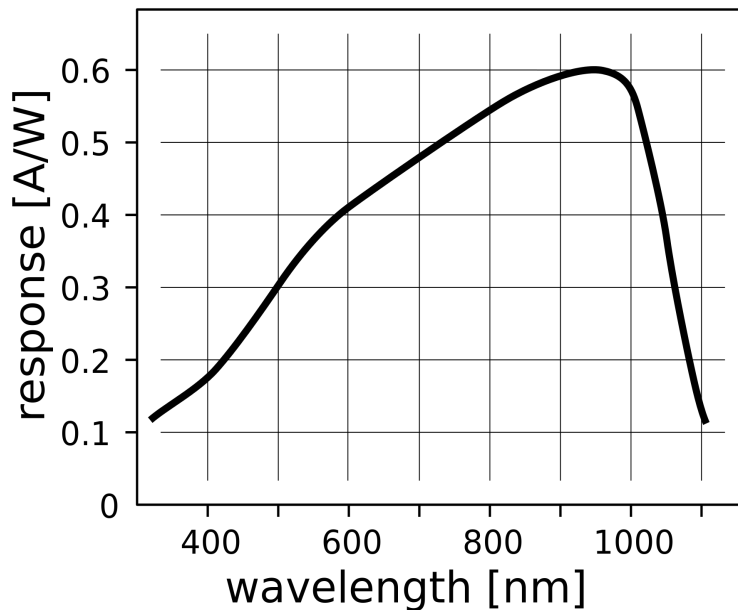

**Figure 6. Generic Silicon Photodiode Spectrum**

Additionally, another point of concern is the divergence angle. Due to the way laser diodes are designed, they have a large divergence angle caused by diffraction from when light is emitted from the diode. They typically emit an astigmatic beam with a very large vertical divergence angle and a moderate horizontal divergence. Fortunately, since our project does not need a specific beam profile, this downside will not affect the project performance in that regard, but the high divergence must be accounted for using collimating lenses.

Luckily, many commercial laser diodes come with collimating lenses preinstalled. The divergence shrinks even more after going through the beam expander. While these are all valid ways to counteract beam divergence, these involve increasing the beam size. As such, using a laser diode over other types of lasers forces us to make decisions on whether we want to prioritize a small spot size over a small divergence.

While searching for suitable 940 nm laser diodes, we came across vertical-cavity surface-emitting laser (VCSEL) diodes from RPMC Laser for quite cheap. We purchased their 8 mW VD-0940C-008M-1C-410 VCSEL diodes that come with built-in collimating lenses. These diodes emit a beam with a divergence angle less than 10 mrad along with a 3mm spot size (12). Compared to standard edge-emitting laser diodes, VCSEL diodes offer some advantages. They produce a smaller divergence beam with a good circular beam profile.

Since we are modulating our laser diode, it is also important to note that VCSEL diodes suffer from a negligible amount of relaxation oscillation. In standard laser diodes, when modulating the diode directly through electronics, the diode acts like an RC circuit and has a rise time where the laser power needs to stabilize. The optical power output from the laser diode spikes upwards for a short time before stabilizing at a designated power. For our project, this could cause the laser to become much more dangerous for the eye since the power output will be larger when modulating. In comparison, VCSEL diodes sufficiently damp relaxation oscillation effects and effectively output the same optical power when directly modulated.

### ***3.2.3 Target Board Material***

The target board material plays an important role. For our project, we considered a variety of materials. The main choices we considered include metal, wood, or plastic. Regarding metal and wood, there are some downsides aside from their superior strength compared to plastic. First, we considered how we would make the target board after designing it. Given our team composition and respective experiences, our team is not very inclined towards machining work. Not to mention, our target also needs to be portable and lightweight, so picking these materials could lead to a heavier finished product.

We also must consider how the receivers will catch the light. Given the properties of metal and wood, these materials have extremely low light transmission, so the receivers would essentially have to be exposed to the elements. As a result, we decided on using 3D printed filament. By using a transparent 3D printed filament, we provide a physical barrier to protect the IR receivers from the elements while also allowing them to work as intended. Precision designs for our parts and making fixtures becomes much easier when using a 3D printer.

There are some alternatives to standard filament-based 3D printers such as resin 3D printers. These provide extremely thin layers, meaning highly transparent designs that far surpass standard filament-based 3D printers can be made. Although, resin printers are generally much more expensive for both the resin used to print as well as the printers themselves. Resin as a material is also structurally weak compared to filament-based 3D prints. With more resources available online along with a cheaper cost, we ultimately chose filament-based 3D printing.

Additionally, many 3D printer filaments have good optical properties if processed properly. Some of the most popular 3D printer filaments for making transparent or clear objects are PLA, ABS, and PETG. From research, PETG seems to be the most suitable of these three filaments. PLA is a very cheap filament that is easy to print with but suffers from performance issues such as being weak and susceptible to heat, meaning that it will not be able to be used outdoors like we want to in our project. Additionally, these filaments are difficult to get to be clear. (13)

ABS is a good filament that can be very clear, but it is quite difficult to print. It releases toxic fumes when printing and requires very high temperatures of around 260 degrees Celsius to print as opposed to PLA at around 210 degrees and PETG at 230 degrees. ABS is strong and can be easily processed by using acetone to smooth the material, making the printed part transparent enough that it could be used to make the lenses on the surface of the board. PETG is similar to ABS but exceeds it in durability and strength and is much easier to print. PETG can become quite transparent when processed. PETG also works well at high temperatures and will not deform from being in the sun. For our project, PETG is the most suitable due to its ability to be used outdoors, transparency when processed, and structural strength.

### **3.2.4 Photodetectors**

The main kinds of photodetectors we considered in our project are photodiodes and phototransistors. Both of these detectors typically have a large acceptance spectrum while peaking at a particular design wavelength as shown in **Figure 6** above. Since the laser will be using a 940 nm wavelength output, the peak sensitivity of the photodetector would also have to be at 940 nm for optimal performance. Photodiodes have average sensitivity with the fastest response times, while phototransistors have high sensitivity with average response time.

For our project, the response time is the main objective since we will prioritize quick visual feedback upon hitting the target, so photodiodes are a good choice. Photodiodes produce

a small photocurrent relative to the amount of light striking the active area of the diode. This means that each photodiode would require an amplification circuit to use the photodiode for any activation tasks like we need. Initially, we planned on using photodiodes by themselves, but we realized that there are some issues with these devices.

Since we planned on using our device outdoors, optical noise would be a problem due to the large acceptance spectrum of photodiodes. For example, if the target board was tilted towards the sun, the photodiodes would receive enough light and would consequently turn on the LEDs despite no laser being fired at it. This is why we chose to modulate our light at 38 kHz. The effects of sunlight and other light sources will be significantly reduced as natural 940 nm sources do not oscillate at this frequency. As a result, we changed our photodetectors to TSOP98638 IR receivers (14). These IR receivers are essentially photodiodes with built-in preamplifiers that will only react to light that is both modulated at the matching frequency as well as having a wavelength that the receiver is sensitive to. This particular model is designed to react to 940 nm light modulated at 38 kHz. The spectrum of these receivers spans from 850nm to 1100nm with the peak at 940 nm. Upon sensing the modulated light, the receiver outputs a 0.3V digital signal that a microcontroller can use to do tasks such as turn on the target board LEDs.

### ***Update***

To cut down on costs (i.e. getting our PCB's manufactured), we switched to VS1838B IR receiver modules which effectively act the same way as a normal IR receiver but come with a small LED on the module that flashes in response to receiving a compatible signal. This greatly helped with testing so we decided to keep them in the final design as well.

### **3.2.5 LEDs**

There are two main LEDs used in our project. These include the 860 nm LEDs used in our IR flashlight for the IR display scope and visible light LEDs used for visible feedback on our target board. LEDs have a variety of parameters that were used to guide our decision selection. The most important ones are the amount of power emitted, wavelength, and viewing angle of the LED. Ultimately, all of these parameters relate to the visibility of the LED.

First, the amount of power emitted determines how bright the light will be, which is important as we will need to be able to see it at long ranges. Second, the wavelength is important due to how the human eye functions. The human eye reacts to different wavelengths differently and is the most sensitive to green light. Finally, the viewing angle is by far the most important for our project because it determines how the output light is distributed.

Standard LEDs have diffusive packages and typically have large viewing angles at over 120 degrees, meaning that someone looking at the LED from outside of this range will see a much dimmer light. However, for our project, the viewing angle needs to be small. Using a large viewing angle means that the light will be distributed over a larger area,

which is useless and a waste of electrical power in our project. This is because the user will be typically standing roughly perpendicular to the front of the target board when firing as well as being at least 15m away from the target. Using a simple trigonometric relationship to describe the transverse size of the output beam  $D = 2 * \text{distance} * \tan(\text{viewingAngle} / 2)$ , it is clear that a smaller viewing angle is more useful due to the distance from the board.

At 15m away, a standard 120 degree viewing angle LED would spread light over a 52m area while a 30 degree viewing angle results in a 8m area. However, we also must consider that a user may place the board at a closer distance, so the viewing angle cannot be too small. Taking into account the different variables of wavelength, viewing angle, and power, we decided on the C503B-RCN-CW0Z0AA1 (15) 624 nm red LEDs with a 30 degree viewing angle. While green LEDs would be preferred due to the optical properties of the human eye, the parts we found while researching online do not output enough optical power relative to the amount of electrical power needed for operation.

For the IR LEDs, the decision was based entirely on output power and wavelength. Since our design will use a telescoping lens design that can focus or defocus the LED light, the viewing angle of the light does not matter. As discussed before, CMOS sensors are relatively sensitive to 860 nm light, so the wavelength for these LEDs was selected based on that characteristic. The output power matters since the quantum efficiency of a CMOS sensor is quite low for IR wavelengths. Additionally, since the light will be reflecting off of the target board back into the sensor from at least 15m away, the power outputted by the LEDs needs to be large. We ultimately chose the SFH 4555 860 nm LEDs. These are powerful at 550mW/sr at 100mA (16) but only have a 10 degree viewing angle. Combined with a lens system that changes the angle of the light, these could be used to make a powerful flashlight.

### **Programmable LED Strips**

In terms of the manufacturability of our project, we also considered a good alternative for normal through-hole or surface mount LEDs. This is to use the LED strips for our LEDs in our system rather than individual LEDs. If we use individual LEDs placed around the target, then this means that our PCBs must be very large to connect to all of the LEDs in an area. By using LED strips, all of the LEDs are connected to one large strip that would only need a single connection to the PCB to control the LEDs.

But as we have mentioned previously, there is a major concern in power efficiency in LED strips because the LEDs used in these strips typically have 120 degree viewing angles. Lower viewing angle LED strips are not common on the market, so we would likely have to make our own strip using separately purchased LEDs to make this a feasible design alternative.

### ***Update***

We used ALITOVE WS2812B LED strips in our final design of the target board. These are powered by 5V and are programmable so that different lighting effects could be used when providing visual feedback.



### **3.2.6 Beam Splitter**

There are mainly two types of beam splitters that can be used in our system. These are plate beam splitters and beam splitter cubes. Beam splitters can be used to split one beam into separate beams or combine two beams into one. Plate beam splitters are essentially semi-transparent mirrors that transmit light coming from one side while reflecting light on the other side.

Beam splitter cubes have the same effect but come in a compact glass cube. Since the beam splitter will have to be placed in the rifle internally, it needs to be small and easily alignable. Due to how plate beam splitters work, it would have to be placed at a precise angle within the rifle to properly combine both beams, making aligning difficult or future adjustments difficult. As a result, we chose the beam splitter cubes to use in our project. Additionally, beam splitters come in a variety of percentages for splitting. Typical values for beam splitters include 50:50, 90:10, and 70:30. In our project, we planned to use a 50:50 20 mm beam splitter cube. Due to its small profile, the cube can be installed directly into the interior of the rifle.

### **3.2.7 CMOS Camera and LCD Display**

The CMOS camera and LCD display are the major components in the night vision capability of the system. In our project, the main concern regarding these two components is whether they interact through digital or analog transmissions. We discussed this previously, but using a digital camera and streaming the video to a LCD display would require a large amount of processing power that cannot be handled by a microcontroller. This would require a computing device such as a Raspberry Pi that would solely be used for digital data transfer from the camera to the LCD display. This is also one of the reasons why we stated that the human detection safety system would be hard to implement and considered it a stretch goal.

On the other hand, there is the option of using analog video transmission. Video transmission through analog is very cheap and typically involves using simple RCA and BNC cables for transmission. However, the quality of the video transmitted is often worse when compared to digital transmission. For our project, we ultimately decided on using analog transmission for the camera and display system despite their disadvantages.

On the market, the main kinds of CMOS cameras sold with analog connections are CCTV and other types of surveillance cameras as well as rear view cameras used for parking cars. These types of cameras are perfect for our project because unlike standard CMOS cameras, these cameras do not have built-in IR filtering components that make night vision impossible. In fact, many of these surveillance cameras have built-in IR LEDs that make them specialized for night-time operations.

For our project, we chose to use the PixelMan PMD2A Backup Camera. This camera uses a 1/2.7-inch color CMOS sensor (5.37 x 4.04 mm) and outputs a 1080p resolution image. The camera uses a F/1.4 fisheye lens system with a 170 degrees field of view. The camera does not use built-in LEDs (infrared nor visible) for night vision but is designed for light gathering in low-light applications. The camera automatically adjusts the image output based on lighting conditions. This camera requires a 12V source for operation (17)

For the LCD display, there were really no specific requirements when guiding our selection other than its compatibility with RCA cables and its size. The size was a main deciding factor because the LCD display would need to be mountable to the rifle scope while also not being overly bulky. The monitor would also need to be large enough that it would be comfortable to look at while holding the rifle. Generally, the types of monitors that suit these requirements are dashboard LCD displays that are used in combination with rear view cameras in cars.

For our project, we decided on the Padarsey TFT LCD Car Color Rear View Monitor. These displays have a 5-inch screen and output a 800x480 RGB image. Like the camera, these displays require 12V for operation (18). Since the camera and display will be removable, we used a separate 12V Tenergy 2000mAh battery that was solely used for powering these two components.

### ***3.2.8 Audio Amplifier***

Since we are unable to output audio directly from the microcontroller to speaker connection, we need to add an audio amplifier to the system. The audio amplifier is necessary to act as a digital to analog converter between the microcontroller and the speakers that we choose. After doing some research we landed on the SparkFun Audio MAX98357A chip. It is a 9-pin chip that is an easy to use, low-cost digital pulse-code modulation amplifier.

This chip can convert digital audio signals to drive the speakers. Its digital audio interface is highly flexible and supports I2S data. Its single-supply operation is 2.5V to 5.5V and can deliver up to 3.2W of power into a 4Ω load (19). This chip is also a great choice because it comes with a development board called the Audio Breakout MAX98357A that can be used for testing. Once done with testing the function of the breakout board we will integrate only the chip into our design to save necessary space in our design.

#### ***Update***

We used the hot plate and the reflow solder machine when attempting to implement the MAX98357A audio chip on our PCB design. We used approximately 5 audio chips along with the PCB silk screen and all of them bridged no matter which soldering method we used. We decided to omit the audio chip from our design.



### **3.2.9 Speakers**

Based on the constraints mentioned regarding the audio amplifier, we had to choose a speaker to output the signal from the microcontroller that matched the parameters mentioned in the “Audio Amplifier” section. In order for the amplifier and the speaker to be compatible it was important to find one that was rated at an impedance of  $4\Omega$ , and a maximum power rated at 3.2W.

We were able to find a couple of speakers on various sites like Amazon and Adafruit that matched our specifications. The product that we found on Adafruit was a simple 3-inch diameter  $4\Omega$  3-Watt speaker cone that comes with 4 mounting tabs that are 60mm apart. Its price comes in at \$1.95 and comes in a package of 1 which would be ideal for our project since we would only be using 1 speaker. The 2nd speaker in consideration was the “MakerHawk 2PCs 4-ohm 3 Watt Speaker for Arduino” on Amazon. Each Speaker comes in a 30mm length, 15mm thickness, and 27 mm wide package and has a 2-pin terminal connected to the positive and negative power lines. These speakers come in at \$9.99 but they come in a package of 2 which will allow us some wiggle room. Also, since they are provided through Amazon Prime it will allow a very short wait time.

We purchased both speakers and tested which works better in our system based on sound quality and overall packaging. In our system, the usage of the speaker correlates directly to each time the trigger of the laser rifle is pulled. Essentially, every time the IR diode emits light, the speaker should correspond with a sound.

#### ***Update***

We used the hot plate and the reflow solder machine when attempting to implement the MAX98357A audio chip on our PCB design. We used approximately 5 audio chips along with the PCB silk screen and all of them bridged no matter which soldering method we used. Since the audio chip bridged, we omitted the speaker portion of our design as well.

### **3.2.10 Vibrational Feedback**

The addition of a vibrational motor will provide an added level of realism to the user experience by providing a simulated recoil. Although it is a stretch goal for the project, it is a feature that sets our design apart from similar designs. When the trigger to the rifle is pulled ideally the motor should activate for about half a second. The design should place the motor in the stock of the rifle to accurately simulate the recoil after the laser is fired. When considering the different vibrational motors, we took considerations that included price, weight, and operational strength.

The vibrational motor will ultimately only have a positive and negative connection and will be connected to the trigger power system so that when the trigger is pulled the motor should instantly simulate the recoil and tactile feedback. Previously we considered using options of CO<sub>2</sub> or a solenoid to simulate feedback, but each came with their own drawbacks.

## **CO2**

Despite the use of CO2 for recoil is very common and out of the three it would cause the most notable effect, using it in our design would have numerous advantages. Firstly, the use of CO2 would create a need for refueling which we agreed would not be ideal for testing and prototyping. Also, it would require a less than ideal design to create a trigger to open and close the valve of the CO2 canister. Lastly CO2 would be a more expensive option than using an electronic recoil system.

## **Solenoid**

A solenoid is a device consisting of a coil of wire, the housing, and a moveable plunger(armature). When an electrical current is induced, a magnetic field forms around the coil and that draws the plunger in instantly thus causing instant haptic feedback. There are three main categories of solenoids: push/pull, latching/bistable, and proportional. The only solenoid we considered for use in our project was the push/pull solenoid.

Despite their interesting design solenoids come with their own set of drawbacks. Two main issues when using solenoids in a design is that since they have a quick pull and quick release, using one would create a somewhat double recoil: one forward and one backward. Also, an issue is that they tend to be very energy consuming so the uptime for our design would be significantly reduced.

## **Parallax Vibration Motor 28821**

This Parallax vibration motor is known as a coin vibration motor due to its round and thin design. Although it is a light weight and slim design it offers a large enough impact to be felt while at the same time it should easily fit within the interior of the rifle. We believe that the device itself should not take much power to function properly. According to the data sheet the motor is rated to operate at a speed of 9,000 revolutions per minute and capable of creating an acceleration of  $22 \text{ m/s}^2$  at a voltage rating of 2.7V to 3.3V and current of 90mA (20).

Another key feature of this vibrational motor is that it is supposed to be highly durable. In fact, it is supposed to be able to survive a fall from 1.5 meters. The implementation of this component should be focused on the stock of the rifle so the small, yet durable design of the device is very helpful. The unit price of these motors come in at \$4.95 so if necessary, we can purchase 2 and utilize them both to increase the feedback.

## **Parallax Vibration Motor 28822**

Despite this device being another parallax vibrational motor its design is similar to that of a cylinder. Its design is larger and heavier than that of the previous motor, but it is also able to provide a stronger force. However, the tradeoff to applying a stronger force this device requires a much larger current compared to the last motor. The 28822 can ideally provide a speed between 9,500 to 14,500 revolutions per minute at a voltage rating of 2.2V to 3.6V and current rating of 250mA (21).

Also, based on the direction in which the power flows through the system, it allows you to run the motor clockwise and counterclockwise. It can create an acceleration of  $22 \text{ m/s}^2$  which should provide enough force to simulate a realistic recoil after pulling the trigger of the laser rifle. An important design feature to note is that the motor has a large off centered mass so it must be effectively tested before placement within the rifle can be decided. The price of each component comes in at \$6.95.

### **Vibration Motor Selection Conclusion**

Both vibration motors only have a positive and negative connection so ideally when it will be connected to the trigger power system. When the trigger is pulled the user should instantly feel feedback from the motor. Both motors listed above can be utilized in either the clockwise or counterclockwise direction. This means that if the output of both devices turns out to be inadequate then we will be able to have one operating in the clockwise direction and another in the counterclockwise direction to output larger feedback.

Each motor requires only about half of its required current to overcome its internal inertia and counteract the static forces within. Since both motors are somewhat similar, we believed that it was imperative to fully test both devices once the frame of the rifle was finalized. Therefore, we purchased both devices and tested them to see if a combination of two is necessary.

### ***Update***

We tested the Parallax Vibration Motor 28821, Parallax Vibration Motor 28822, and the Vibration ERM Motor 2550 RPM 5V from Vybronic Inc. When testing the vibration motors, we noticed the voltage regulators on our PCB began to overheat. Therefore, to prevent any failures in our system, we decided to omit this portion of our design.

## **3.4 Processor Research**

To ensure we design and implement a superior product we must determine an optimal microprocessor for our design. There is a vast variety of microprocessor products on the market and within the industry that many companies and independent developers use. To determine the processor that is well suited for our project design we must look at the requirements that need to be achieved. The microcontroller unit will be required for communication with peripheral devices such as the IR laser diode, visible laser diode, LEDs, IR LED, IR receiver, and vibration motor.

Communication between the microcontroller unit and the rifle as well as communication between the microcontroller unit and the target are needed to input and receive data accurately and reliably. The most well-known communication tools used today are Bluetooth and Wi-Fi. Bluetooth and Wi-Fi are both advanced communication tools used to transfer data and information quickly and seamlessly across one device to another. Bluetooth has quickly advanced over the years with us now having Bluetooth version 5.0-5.2 which allows for an increase in the bandwidth capacity over prior versions of Bluetooth.

The newest versions of Bluetooth also allow for lesser power consumption and multi-point connectivity which allows multiple devices to be connected at once.

Along with Bluetooth, Wi-Fi has also seen serious technological advances over the years with us now having Wi-Fi 6. The newest version of Wi-Fi also allows for the increased bandwidth capacity by nearly double over prior versions. The newest version of Wi-Fi also allows for quicker data transfer speeds over prior versions of Wi-Fi as well as increased safety which decreases the chance of leaking sensitive information. The choice between Bluetooth and Wi-Fi is an important factor in the choice of our microcontroller unit as well as the development of our Laser Target-Shooting design. Comparing the data within our research allows us to make an informed decision to ensure optimal functionality within our project design.

## **Bluetooth**

For our project, we considered Bluetooth because it is an advanced communication tool used to transfer data and information quickly and seamlessly across one device to another. Bluetooth technology has quickly advanced over the years with the most current versions of Bluetooth being Bluetooth 5.0-5.2. The newest 5.0 versions of Bluetooth allow for an increase in the bandwidth at approximately 2.0 Mbps capacity over the prior versions of Bluetooth 4.0 at 1 Mbps. An advantage of the newest versions of Bluetooth 5.0 is also lesser power consumption compared to Bluetooth 4.0 and multi-point connectivity which allows multiple devices to be connected at once. Bluetooth works by broadcasting a radio signal with a specific unique address to other transmitters in the vicinity such as a cellular device. The two devices connect and create a personal-area network.

A known disadvantage to Bluetooth compared to Wi-Fi is the connectivity range. Bluetooth is known to have a shorter connection range between devices compared to Wi-Fi. Bluetooth also only has the capability of working on a 2.4GHz frequency whereas most current Wi-Fi networks work on both 2.4GHz and 5.0GHz. Bluetooth overall is meant to be used for small-area networks to connect devices together without the use of an internet connection. Bluetooth provides a weaker signal overall at approximately 1 milliwatt compared to Wi-Fi but that is not necessarily a bad thing.

Bluetooth is a great option to use for a more isolated project such as ours since the chance of interference with other wireless devices is much smaller. Bluetooth has the option of channel hopping, which means when another set of devices within the same vicinity are also connected using Bluetooth and they somehow end up on the same channel, they will switch channels within a second therefore the set of devices will not interfere with one another. A great example is when a phone is connected to a car's Bluetooth and you are driving, other cars in the area will also be connected to Bluetooth with their phones. To prevent any interference between vehicles, the Bluetooth transmitter in your vehicle will constantly switch frequencies to stay off the frequencies of the vehicles in the surrounding area. (22)

## Wi-Fi

Wi-Fi, similar to Bluetooth, is an advanced communication tool used to transfer or download data and information quickly and seamlessly to a device or multiple devices. We have seen past UCF Senior Design groups with similar projects use Wi-Fi in their projects over Bluetooth, so it is natural that we must do research to determine how W-Fi compares to Bluetooth. Wi-Fi has seen serious technological advancement over the years with the newest version being Wi-Fi 6. The newest version of Wi-Fi also allows for the increased bandwidth capacity by nearly double over the prior versions. The newest version of W-Fi also allows for quicker data transfer speeds over the prior versions of Wi-Fi as well as increased safety which in turn decreases the chance of leaking personal data or sensitive information. A significant difference between Wi-Fi and Bluetooth is that Wi-Fi has the capability of connecting a multitude of different devices while being used on the same Wi-Fi network.

The standard for today's Wi-Fi networks is 802.11 which comes in many different varieties. Today's network standards include 802.11a which uses a 5GHz frequency band as its standard which allows data to move up to 54 Mbps. 802.11a uses an orthogonal frequency-division multiplexing technology to split the radio signal into separate sub radio signals to aid in reducing outside interference. Wi-Fi networking standard 802.11b is the slowest Wi-Fi network but also one of the most popular for the common consumer or user. 802.11b uses the 2.4GHz frequency band which only allows for data to move up to 11 Mbps. Wi-Fi networking standard 802.11g has similarities to the 802.11b Wi-Fi networking standard. Wi-Fi networking standard 802.11g also uses the 2.4GHz frequency band however the 802.11g networking standard can send data at 54 Mbps like the 5GHz frequency band due to the orthogonal frequency-division multiplexing that's also used in the 802.11a networking standard.

The 802.11n networking standard is one of the most widely used Wi-Fi networks by the common consumer or user, even more so than 802.11b. The reason the 802.11b networking standard is so popular is due to its backwards compatibility to the prior versions mentioned, 802.11a, 802.11b, and 802.11g. The 802.11n also has far greater data transfer compatibility with the ability to use four data streams and transmit data at 150 Mbps using the orthogonal frequency-division multiplexing with the ability to use 2.4GHz or 5GHz frequency bands. This makes the 802.11n the most popular consumer Wi-Fi networking standard for home use.

The newest networking standard is the 802.11ac which is essentially an updated and most efficient version of the 802.11n networking standard. The 802.11ac is still under development and review which is why it has not completely taken over the 802.11n networking standard. The 802.11ac is like the 802.11n in the sense that it also has backwards compatibility functionality with every other networking standard. The 802.11ac could function on the 2.4GHz and 5GHz frequency band but has the ability to transmit and transfer data at 450 Mbps. Wi-Fi and Bluetooth share a common spot on the visible spectrum graph between 300 MHz and 3 GHz. However, Wi-Fi is quickly advancing and is beginning to find itself in the 3 GHz and 30 GHz range. These separate bands are the



reason we do not notice any interference between the Wi-Fi, radio, and television in our homes. (22)

### **3.4.1 Choosing Between Bluetooth and Wi-Fi**

Choosing to use either Bluetooth or Wi-Fi is an important decision to make for our project's app functionality. We will weigh the pros and cons from our research in the previous section to choose the best option. Both Bluetooth and Wi-Fi have gone through serious technological advancements. Both Bluetooth and Wi-Fi are means of transferring data quickly and seamlessly across one device to another, or across multiple devices. Some advantages of the newest versions of Bluetooth include an increase in bandwidth at approximately 2.0 Mbps capacity over prior versions at 1 Mbps. The newest versions of Bluetooth also have lesser power consumption and multi-point connectivity to allow multiple devices to connect at once.

When two or more devices connect with Bluetooth, a radio signal is broadcasted with a unique address to other transmitters in the vicinity so there is no interference with other devices. Bluetooth is a great option for small-area networks to connect two or more devices together without the use of an internet connection. Bluetooth's range is much shorter than Wi-Fi but for our project that is not an issue. The phone, laser gun, and target will all be within close vicinity of one another. Bluetooth is a great option to use for an isolated project such as ours due to the lesser chance of interference with other devices.

Some disadvantages of Bluetooth are the capability of only working in the 2.4GHz frequency band, whereas most Wi-Fi networks work on both 2.3 GHz and 5.0GHz frequency bands. Bluetooth also provides a weaker signal at approximately 1 milliwatt compared to that of Wi-Fi. Due to Bluetooth's weaker signal, range is also sacrificed, the range on Bluetooth will only reach approximately 30 meters whereas the newest editions of Wi-Fi can surpass a 100-meter range. Data transfer speeds are also a disadvantage when considering Bluetooth vs Wi-Fi, for example, Bluetooth 4.0's transfer speed only goes to approximately 25 Mbps whereas the newest versions of Wi-Fi have transfer speeds up to 450 Mbps.

Wi-Fi has disadvantages of its own over Bluetooth. When using Wi-Fi, you must consider that on a public network, anyone can connect to your Wi-Fi connection. As more and more devices begin to connect to a Wi-Fi network, then bandwidth will start to become limited. Although more devices can typically connect to a Wi-Fi network over Bluetooth, Bluetooth for us is a better option to avoid outside interference and bandwidth limitations. Data transfer speeds are not a current concern of us right now, but it is something to consider in the future. The range is not a concern for us since our devices will all be within proximity of one another. The weaker signal is not a current concern of ours since the phone, laser gun, and target will all be within proximity to one another. The consensus is to use Bluetooth to lessen power consumption, avoid outside interference, and avoid bandwidth limitations.

## **3.4.2 MCU Technology and Specifications**

### **Arduino Mega 2560**

The Arduino Mega 2560 is a popular and well-known microcontroller to use for personal projects. The Arduino Mega 2560 has 16 analog inputs, 4 UART serial ports, 16 MHz crystal oscillator, 54 input/output pins, USB connection, power jack used via computer or external battery, In-Circuit Serial Programming (ICSP) header, and a reset button. The Arduino Mega 2560 operating voltage is 5V with a recommended input voltage of 7V-12V. The clock speed of the Arduino Mega 2560 is 16 MHz. The Flash Memory is 256 KB with 8 KB occupied and the SRAM is 8 KB. The Arduino Mega 2560 does not have Bluetooth or Wi-Fi without installing external hardware to the microcontroller (23).

### **MSP-EXP430G2ET**

The MSP-EXP430G2ET is a 16-Bit microcontroller. The MSP-EXP430G2ET has 20 input/output pins, USB connection, Debugging and programming interface, two push buttons for feedback or device reset, a green and a red LED, and MSP430 application UART serial ports. The MSP-EXP430G2ET has 16 KB of Flash Memory, 512 bytes of RAM, a clock speed capable of 16 MHz CPU speed, 10-bit ADC, enabled Input/Output with capacitive-touch, and universal serial communication interface. The MSP-EXP430G2ET does not have Bluetooth or Wi-Fi without installing external hardware to the microcontroller (24).

### **ESP32-WROOM-32D-N4**

The ESP32-WROOM-32D-N4 supports 32-bit operations. The ESP32-WROOM-32D-N4 has 38 pins including input/output, 3V3, GND, Sensors, and clock. The ESP32-WROOM-32D-N4 peripherals include, SD card interface, UART support, SPI, SDIO, I2C, IR which is important to our project, and capacitive touch. The ESP32-WROOM-32D-N4 has a 40 MHz integrated crystal, a 2.4 GHz – 2.5 GHz operating frequency, a 2.7V – 3.6V voltage supply, a 4 MB integrated SPI Flash, 520 KB of on chip SRAM, and a clock frequency which is adjustable from 80 MHz to 240 MHz which has two CPU cores that can be individually controlled. A large advantage of the ESP32-WROOM-32D-N4 over the Arduino Mega 2560 and the MSP-EXP430G2ET is Bluetooth and Wi-Fi capability without requiring external hardware to be added. The ESP32-WROOM-32D-N4 uses Bluetooth 4.2 and Wi-Fi networking standard 802.11 b/g/n. Using this microcontroller will allow us to connect to a phone via Bluetooth to integrate our phone application (25,26)

## **3.4.3 Arduino Mega 2560 vs. MSP-EXP430G2ET vs. ESP32-WROOM-32D-N4**

This section is meant to compare the three microcontrollers Arduino Mega 2560, MSP-EXP430G2ET, and ESP32-WROOM-32D-N4 to determine which microcontroller is best suited for our project. When deciding which microcontroller is best for our project we need to consider all the hardware we will implement such as IR module, speaker, and IR

receiver. Clock speed determines how quickly instructions are executed for the specific processor. Using a microcontroller with a higher clock speed will allow more instructions to be executed overtime compared to a microcontroller with a lesser clock speed. There are some trade-offs for using a high clock speed microcontroller. Using a microcontroller with a high clock speed means a more intricate design which will directly increase the cost. A higher clock speed also leads to greater power consumption relative to a microcontroller with a smaller clock frequency.

Keeping the cost and power consumption to a minimum is an important aspect to consider when selecting parts and designing an engineering project. Although price and power consumption will be increased, having a high clock speed microcontroller proves its worth, being able to compute vastly more instructions in a shorter period of time. Having a microcontroller with a high clock speed will allow for data to be received and communicated very quickly across devices. For our particular project, the three microcontrollers we are comparing all have sufficient clock speeds, however, the Espressif Systems microcontroller we chose allows for higher clock speeds compared to the Arduino and Texas Instruments microcontroller.

Memory is an important factor to consider based on how strenuous the programs will be that are running on it. The memory found in a microcontroller is where data and information is stored once received. The data within the microcontroller's memory is used to respond to instructions based on the program being used (27). The more programs and functions being performed at once will require more memory from the microcontroller. The read and write time on the microcontroller will be affected by the program(s) being run.

As a program becomes more complex, the more data and resources needed for the microcontroller to store the information in its memory. When using a microcontroller we must consider that the memory capacity is significantly smaller than that of a present desktop computer. Choosing a microcontroller with a large amount of memory can quickly become expensive.

For our project we want to ensure the microcontroller we choose can handle our software without any memory issues. It's important to remember that long-term information or program memory is non-volatile memory. Non-volatile memory is information stored within the memory without requiring a power source. Storage of temporary data or data memory is volatile. Volatile memory is data that is held temporarily, meaning the microcontroller needs to be connected to a power supply to hold onto the data.

Choosing a microcontroller with less built-in memory such as the Arduino or Texas Instruments microcontroller can potentially limit our software capability. To implement various functions such as games, number of targets, ammo capacity, and firing mode, it's a safer bet to choose a microcontroller with more memory. For our project, comparing the three microcontrollers, it's seen that the Espressif Systems microcontroller we chose allows for the largest amount of on board SRAM compared to the Arduino and Texas Instruments microcontroller. **Table 2** below shows the main factors



we considered when deciding which microcontroller to use. Considering the ESP32-WROOM-32D-N4 is the only microcontroller we researched that allows Bluetooth and Wi-Fi communication without additional external hardware being added, we believe the ESP32-WROOM-32D-N4 will be best suited for our project design and development.

Company	Arduino	Texas Instruments	Espressif Systems
Microprocessor	Arduino Mega 2560	MSP-EXP430G2ET	ESP32-WROOM-32-N4
Operating Voltage	5V	1.8V – 3.6V	2.7V – 3.6V
Bluetooth (Stock)	No	No	Yes
Wi-Fi (Stock)	No	No	Yes
Clock Speed	16 MHz	16 MHz	80 MHz – 240 MHz
Availability	Available/Own	Available/Own	Available/Own

**Table 2: Microcontroller Comparison**

### ***3.4.4 Development Board***

For our project we used the ESP32-DevKitC core Board for ESP32 Development Board ESP32-WROOM-32D which is compatible with Arduino. A development board is needed for active prototype testing of our project before actual implementation takes place. We have two boards that were used for testing the laser gun as well as the target. The ESP32-WROOM-32D microcontroller has 38 available pin connections. Each pin serves a specific function for which we connected to hardware on our laser gun as well as the target.

## **3.5 Power Research**

In order to create any electronic design it is quintessential to utilize the appropriate power source. It is important to consider the appropriate methods, standardized practices and considerations when looking to manipulate a power in a manner that is safe and efficient for internal and external components in our design. This section will outline the methods and means that we considered in order to select, manipulate and regulate our power supply for both our laser rifle design and our laser rifle target. Both the rifle and target systems will require a source that can accommodate a microcontroller unit and various user end components.

### ***3.5.1 Sources and Regulation***

#### **Laser Rifle**

The main component of our system is the rifle itself. The power requirement for this system is that it should be able to supply at least an input voltage of no less than 5V to power the MCU that will control the trigger system and communication to the user end app. The rifle power source will also power the IR diode and haptic feedback. We would like for the rifle to retain a reasonable weight so that it is not too heavy but also not too light so it not exceeding 10 lbs is ideal. This allows for significant maneuverability when choosing the battery system design since the frame is no more than 4 pounds. Although it would come at a higher cost than disposable batteries, ideally a rechargeable battery pack would be well suited for the rifle.

### **Target Board**

Power requirements for the target board will need to be as capable as the source as the laser rifle despite the target design being different. The target board will most likely contain a similar MCU, IR sensing and LED indication so that no less than 5V requirement will be necessary. A DC supply no less than 5V will also leave room for any stretch goals that will be considered later. Again, both devices will provide a mobility aspect so this system should be powered by a rechargeable battery pack as well.

### **Regulation**

When designing systems that include different components but one power source it is necessary to include voltage regulation. Power regulation will be pertinent for protecting integrated circuit components while supplying the necessary potential voltages. To not overload the 5V MCU which is integral to both the rifle and target board systems we will be looking to provide DC sources that can be stepped down or stepped up to acquire appropriate input voltages.

## ***3.5.2 Battery Technology***

Designating which battery technology to use is always an extremely crucial step to any electronic system design. The batteries that were considered for this project led us to research Lithium-Ion, Lithium Polymer, Nickel Cadmium and Nickel Metal Hydride. To choose the appropriate battery technology limitations such as weight, pricing and efficiency were taken into account.

### **Nickel Metal Hydride vs Nickel Cadmium**

Ni-MH batteries are a type of rechargeable battery that is commonly used in many electronic devices like laptop computers, mobile phones, and cameras. The negative terminal of the battery is made of a hydrogen-absorbing material and often different inter-metallic compounds while the positive is made of nickel-oxide hydroxide. A couple of its advantages over Nickel Cadmium based batteries are that they have improved energy density with a higher capacity of roughly 30 to 40 percent, they require lower maintenance, have excellent safety performance and are environmentally friendly with few toxins. While disadvantages are listed, the Ni-MH batteries have longer charge times that require

careful control of trickle charging and tend to be more expensive. Research also reveals that both have an average nominal voltage of 1.25V per cell.

### **Lithium-Ion(Li-ion) vs Lithium Polymer(Li-Po)**

Li-ion batteries are mostly made of lithium while the cathode is made of graphite, cobalt, or manganese. This type of battery utilizes a liquid electrolyte for electrons to flow. Li-Po batteries are similar to Li-Ion however instead they use a gel like electrolyte. The key advantages of Li-ion batteries are that a typical Li-ion battery can store 150 watt-hours per kg of battery, they hold charge well, and they can handle more charge/discharge cycles. Li-Po batteries' key advantages are that they are compact in size, very safe compared to Li-ion, light weight and have a larger life span. The nominal cell voltage in a Li-ion battery is around 3.2V while the nominal cell voltage in a Li-Po battery is about 3.7V.

We made **Table 3** below to get a better numerical comparison of each battery. After strong consideration we found that the voltage level that best suited our engineering directives would be a power source ranging at around 9V. At this voltage we found fast charging speed to be a deciding factor. A quick recharging turn-around would surely benefit the user in the long run. Therefore, we decided to choose a 9.6V Ni-MH rechargeable battery pack for both the target and the rifle. The extra weight that the 9.6V battery pack provides will also provide some stabilization for the target board as well.

<b>Battery Type</b>	<b>Nickel-Cadmium</b>	<b>Nickel-Metal Hydride</b>	<b>Lithium Polymer</b>	<b>Lithium-Ion</b>
<b>Energy Density (Wh/kg)</b>	45-80	60-120	100-130	110-160
<b>Fast Charging time</b>	2-4h typical	1h	2-4h	2-4h
<b>Cell Voltage</b>	1.25V	1.25V	3.7V	3.7V
<b>Battery Cost</b>	\$50	\$60	\$70	\$70

**Table 3. Comparison of Batteries**

### ***3.5.3 Charging Technology***

#### **Constant Current & Constant Voltage**

Constant current charging is a method of continuously charging a rechargeable battery at a constant current to prevent overcurrent charge conditions. Constant voltage charging is a method of charging at a constant voltage to prevent overcharging. The charging current is initially high then gradually decreases. These 2 are the most common battery

charging methods. Both methods include their own sets of advantages that allow for battery charging efficiency so a dual method was introduced to include both.

Constant voltage/ Constant current (CVCC) is the combination of the mentioned 2 where the charger limits the amount of current to a pre-set level until the battery reaches a pre-set voltage level. The current then reduces as the battery becomes fully charged. A Lithium Ion battery is being strongly considered for this project and the CV/CC method is a very typical method of charging Li-ion batteries. This method of charging is efficient for mobile devices and allows for higher device uptime.

### **Battery Management System (BMS)**

Battery management systems are electronic control circuits that monitor and regulate the charging and discharging of batteries. The importance of the system lies in its ability to ensure the optimal use of the residual energy present in the battery. The system can be used to monitor characteristics like the detection of battery type, voltages, temperature, capacity, state of charge, power consumption, remaining operating time, and charging cycles. For the prototyping of our design the main focus will be on the BMS chip's ability in Passive Protection and Basic battery life monitoring. Additional design considerations may fall into the realm of digital communication via Bluetooth between the devices and the systems app.

### ***3.5.4 Voltage Regulators***

A voltage regulator is a component used to ensure that a steady constant voltage is supplied through all operational conditions of necessary devices. It will usually take in a higher input voltage and emit a lower, more stable output voltage. It is needed to keep voltages within the prescribed range that can be tolerated by the electrical equipment in using said voltage.

For example, if there is a 12V supplied voltage but a component operates at a much smaller range say about 3V then one can use a regulator to drop that 12V to a range of 2.7-3.3V to satisfy that device. For this project the battery technology being considered is about 12V and above for our voltage supply. Ideally, we would like to utilize regulators to limit the current and voltage inputs the microcontroller and peripheral devices obtain to achieve optimum power efficiency in our system.

### **Linear Regulators**

Linear regulators use linear, non-switching techniques to regulate the voltage output from the power supply. It operates by using a voltage-controlled current source to force a fixed voltage to appear at the output. They require an input voltage at least some minimum amount higher than the desired output voltage. Linear regulators are highly considered in the regulator selection since their implementation is simple, low cost and low noise.

For our design it is necessary to utilize linear voltage regulators at optimal voltage levels to power the microcontroller, IR laser diode, IR receivers, LED array on the target

board, and speaker unit. Although there are 3 basic regulator designs for regulators: Standard (NPN Darlington) regulators, Low Dropout or LDO Regulator, and Quasi LDO regulator, after extensive research it was found that the Low Dropout Regulator seems to be more optimal for our design. The reason being that it is best suited for battery-powered applications.

### **TPS76333**

The TPS76333 is a low-dropout voltage linear regulator that offers the benefit of low power operation and miniaturized packaging. The input voltage is limited to 2.7V minimum to 10V maximum. It will provide a regulated output voltage of 1.6V to 5V while having a current of 2uA. It comes in a 5-pin packaging and although normally are provided as fixed voltage regulators it also comes in a variable version that can be programmed to output within the 1.6V to 5V range. Although the price of the regulator is a little higher than that of most, it can be very useful in providing the 3.3V and 5V outputs we are looking for. \$1.24 per

### **LM7805**

Unlike the TPS76333 the LM7805 is a 3 terminal linear regulator. It can accept an input voltage of 5V to 18V and retain an output voltage of 5V, 12V or 15V. It provides internal current limiting, thermal shutdown, and safe area compensation, making them very safe for PCB use. The safety features of these regulators and the fact that we have used these regulators in a previous project make them a strong contender for use to step down our voltage from 9V to 5V. The price generally comes in around \$1.82 per regulator which again is a little pricey but would be worth it.

### **TC1262**

The TC1262 regulator is a fixed output high accuracy CMOS low dropout regulator. It is generally used for battery systems which is exactly what our rifle system and target system are based on. The CMOS construction eliminates wasted ground current, significantly extending battery life. We are looking to keep our system low energy so that our devices can have an uptime of at least 4 hours. This regulator takes in a maximum input of voltage of 6V and provides a regulated 3.3V. The cost of this package is generally \$.62 per.

### **LD1117AS33TR**

The LD117A is a low drop voltage regulator. It comes in adjustable and fixed voltages such as 1.2V, 1.8V and 3.3V. It also comes as multiple 3-pin variations that include through hole and surface mount. High efficiency is assured by NPN pass transistors. Ideally for our design we would like to include as many surface mounts as possible because surface mounted packages optimize the thermal characteristics while offering a relevant space saving advantage. The operating DC input voltage is 10V while the maximum rating is 15V. The price for this comes in at about \$.90 per regulator and in high stock on Digi-key.

## **TPS82150**

The TPS82150 is a 17V input 1A step down converter module that is optimized for small solution size and high efficiency. It comes in a 8-pin package and includes options for power save mode, where the device can operate with typically 20uA quiescent current. We could use this converter to provide an adjustable output thus allowing it possible to create the 3.3V and 5V voltage rails necessary to power our components. The price per each module comes in around \$1.47 making it the most expensive regulator under consideration. We provide a comparison of these components below in **Table 4**.

	<b>Max Vin (V)</b>	<b>Nominal Vout (V)</b>	<b>Voltage drops (V)</b>	<b>Output current (mA)</b>	<b>Additional component req</b>
<b>TPS76333</b>	2.7 - 10.0V	1.6 - 5V Variable	0.18	800	1uF input capacitor
<b>LM78</b>	2.7V - 18V	5V - 15V fixed	2.00	1000	0.33uF Vin, 0.1 uF Vout
<b>TC1262</b>	2.7 - 6.0V	2.5 - 5.0 fixed	0.35	500	1uF Output
<b>LD117A</b>	10 - 15V	1.2 - 3.3V Fixed	1.0	1200mA	10uF cap for stability
<b>TPS82150</b>	3-17V	0.9-6V Variable	(low)	1000	Resis divider, @ pin6

**Table 4. Voltage Regulator Comparison**

## ***3.5.5 MOSFETS***

Metal-Oxide-Semiconductor Field-Effect Transistors are three-terminal devices that allow the user properties of enabling precise control of the current flowing through the component. The body of the device has three connections, it has a source (S), gate (G), and drain (D). The main principle of the MOSFET device is to be able to control the voltage and current flow between the source and drain terminals. It works almost like a switch and the functionality of the device is based on the main part; the MOS capacitor (28). The application of the device that we are most interested in for this project is its ability to act as a voltage-controlled resistor in analog circuits or as an ON/OFF switch in digital circuits. This application can be quite significant in our pursuit of designing a suitable laser diode Driver.

## **FQP50N06L**



This is an N-Channel enhancement mode power MOSFET tailored to reducing on-state resistance. It can provide superior switching performance and high avalanche energy strength. These devices are applicable for switched mode power supplies, and variable switching power applications. It has a drain-source voltage 60V, a gate source voltage of plus or minus 20V and lastly a drain current of 37A. This device comes in a through hole packaging which again is not ideal for the space requirements for our design but will be optimal for testing. Although the components specs are higher than what we require it would be helpful to test the component and observe whether it can be utilized. This device can be ordered from Mouser for \$1.85.

### **IRFZ44VPBF**

Fairly similar to the previous MOSFET this is another 3 pins through hole MOSFET. The capabilities of this device allow for fast switching speed and extremely efficiency and reliability. It also is preferred for commercial application due to its high levels of power dissipation at approximately 50 watts. This power dissipation is much higher than would be necessary but could be useful. It also has a drain source voltage and a drain current of about 55A. Since we are not very familiar with utilizing a MOSFET in design it is of the group's belief that we purchase both components and test to see whether they are able to satisfy our laser driver needs. This MOSFET can be ordered from DigiKey at a price of \$1.56.

## **3.5.6 OP AMPS**

OP-Amps are linear devices that are ideal for DC amplification and are often used in signal conditioning, filtering or other mathematical operations such as: addition, subtraction, integration, and differentiation (29). These multi-purpose components are able to retrieve an input signal or difference between two signals and amplify based on the design and application. We are currently looking into multiple ways to drive the laser diode while conserving energy. In our research we have found that the application of using an OP-Amp in our design can achieve such a result.

### **TS972IPT**

The TS972IPT operational amplifier is well suited for portable and battery-supplied equipment. It is supposed to be capable of very low noise and low distortion characteristics. Usage of this amplifier is limited to a 12V ceiling and a 2.7V minimum input supply. The packaging that we are considering is a low profile SMD with a 100mA being the maximum output current (30).

It is recommended that when designing with a op-amp you need to add a capacitor to the output in order to limit the exposed higher frequencies of the DC transistors inside the package, however when going over the datasheet for this device there were no such recommendations to add any additional components outside of the common biasing practices. The price of this op amp comes in at \$1.37.



## **TL084CN**

The TL08x series of operational amplifiers can be used in many different applications depending on the design. This particular version that we considered allows for four separate outputs to be utilized within a single package. According to the datasheet it is rated to operate at maximum supply voltage of 36V and is a throughhole component. Relative to our current design constraints regarding PCB design size it would effectively take up too much space but would be easy to use in a breadboarded prototype.

This component operates on a rail to rail power supply and will clamp the output to a specific rail if improper biasing occurs. The applications that would be of use to our project is its use as a logic gate. Due to the general purpose of this amplifier one can utilize it in combination with a non-inverting amplification format to deliver a calculated amount of power to the laser driver at a slew rate of 13V/us. This can also be implemented as a safety component by further restricting possible damages to the laser diode. This device can be purchased from digiKey for \$0.62.

### ***3.5.7 Battery Power Conclusion***

With all the design requirements and standards taken into consideration we ended with a battery selection of a 9.6V 2000mAh Ni-mH rechargeable battery. Although providing a battery management system was highly considered in the initial design, we have proceeded with omitting that until the foreseeable future. Reason being that batteries that included the BMS system chip were only within the range of 3.7V and below. During the selection process we did consider a Lithium Ion 3.7V 4400mAh battery pack from Adafruit.com and a 2.4V NiMH 3700mAh battery pack from Digi-Key.

While both products offer sufficient capacity for powering the laser rifle and target, including a low voltage system would require the use of a boost voltage converter and ideally we would like to avoid the energy efficiency penalties. We found early on that a simple voltage buck/ step down regulator design was more efficient and flexible. The choice of 9.6V 2000mAh Ni-mH also comes with its own set of penalties since we will be working with a smaller current capacity but we can more than make up for that by using dynamic sleep profiles for the ESP32 microcontroller that was chosen.

### ***3.5.8 Voltage Regulator Conclusion***

After finalizing the battery selection process the voltage regulator selection went under consideration. For our system it is necessary that we include regulator designs that can output stable and efficient 3.3V and 5V bus. The 3.3V bus will be essential in safely powering components such as the audio system in the rifle, the vibrational motor in the rifle, the IR receiver in the target and the microcontrollers on both the target and rifle .

While the 5V rail will be important in supplying stable power to the IR diode inside the rifle, the IR flashlight on the gun and the indicator LED strip display on the target. A simple

parallel system design would allow us to bypass the efficiency penalty incurred with a sequential voltage buck design and would allow us to eliminate any need for an expensive buck-boost IC. Ideally it would allow us to use the same power design for both the target and the laser rifle. **Figure 7** below shows a general description of how ideally the voltage rails interact with various components.

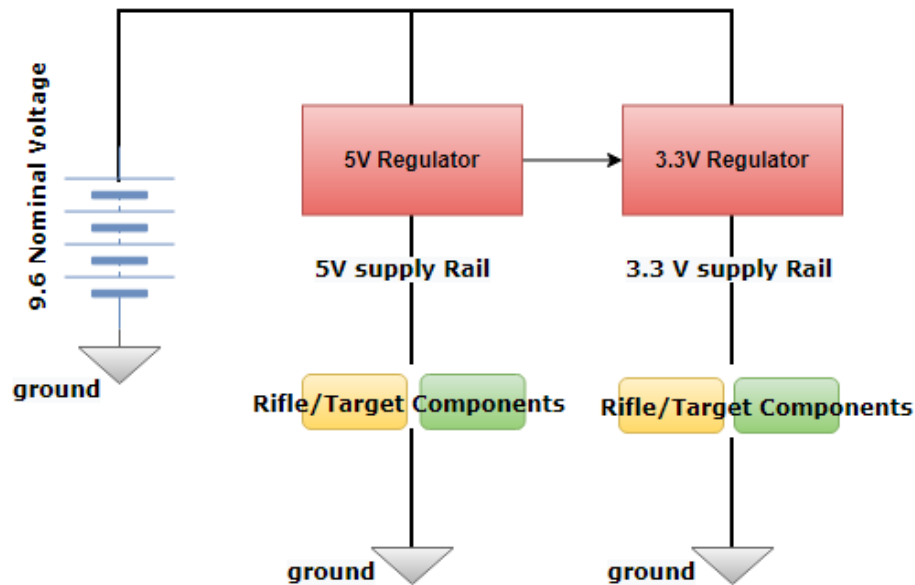

**Figure 7. Voltage Rail Description**

Originally it was the opinion of our team to use the TPS76333 voltage regulator since it is fairly common and can be easily applied; however it only allows for an input voltage of 10V. Since we are using a 9.6V battery pack we must consider the chance of over voltage therefore we are looking toward an option of at least 12V. With that considered it is our team's opinion that we should use 2 UA78M voltage buck regulators for our 3V3 rail and 5V rail.

## 4.0 Related Standards and Design Constraints

Standards are an integral part of our project. These standards provide the guidance of how we stand, operate, communicate and develop new ideas. Constraints further enhance our awareness of the design. What constraints are defined as a rule, requirement, or limiting factor placed on the design as part of the project assignment.

During the ABET lectures in the Senior Design class, several categories of constraints were introduced. Each one of these categories was researched carefully so that we can

place down the relevant constraints for the section. This section will be used to discuss all standards and all known constraints. We will explain how they are applied to our project and what are the reasons behind these decisions.

## **4.1 Standards**

The definition of standard is a “document that defines the characteristics of a product, process, or service, such as dimension, safety aspects, and performance requirement” (31). Standards development began by committees, organizations, or government departments. For example, groups consist of Institute of Electrical Engineers (IEEE), American National Standards Institute (ANSI), and Institute of Printed Circuits (IPC) and many more. Overall, standards are developed by hundreds of professional and technical organizations.

That is why analyzing and identifying related standards is an important aspect of the design process in the engineering project. Standards are to protect our health, safety, and environment. Therefore, many design decisions were considered to satisfy the need of system requirement standards.

This section will discuss several standards related to this project, including standards for soldering and hardware safety, prototype testing and software testing, product reliability, documentation, and programming language standards.

### ***4.1.1 Hardware Soldering Standards***

Since our project will require a significant amount of soldering, we found it important to include soldering standards. IPC J STD 001 (32) is a soldering standard for electronic components and electrical assemblies. The standard identifies material specifications, process requirements and acceptability criteria. Originally this standard was accepted in 1992 and has had multiple revisions since. The current version of this document is J-STD-001 H. It outlines methods, materials, and verification criteria for creating quality, lead and lead free, soldered interconnections. The standard provides an in-depth explanation of the following elements and practices involved:

- Through-hole mounting
- Terminal and wire connection
- Material, component, and equipment
- Soldering and assembly requirements
- Surface mounting of components
- Cleaning and residue requirements
- Coating, encapsulation, and adhesives

The J-STD-001 standard is used as a guideline and provides the best practices to follow for process engineers, supervisors, and technicians. These joint industry standards listed below will be crucial to our design and prototyping process as it will make the soldering process more reliable and consistent. The necessary requirements specified by the J-STD-001 are as listed.

According to the J-STD-001 cleanliness cannot be overlooked. In order to prevent the contamination of materials, tools and surfaces cleanliness must be practiced consistently. Corrosion can be caused by fluxes with powerful properties and so the board's structural elements may be susceptible to residue and cause it to collapse. Therefore, in order to prevent contamination, one must be constantly cleaning materials, processes and surfaces.

Another important requirement is temperature control. Heating and cooling rates ideally should be followed as closely as possible to the manufacturer's instructions. One should practice thermal profiling to determine the excursion throughout the soldering process by measuring many spots on the circuit board. Stacked and laminated chip capacitors are treated as temperature sensitive to prevent thermal shock.

It is also important that soldering must not cause any damage to the wire strands. When working the tinned section of the wire must be thoroughly coated with the solder.

A conformal coating is a protective sheet that acts as a protection against any external toxin to the board. The coating will serve as a protective covering for the PCB surface. Before installing the conformant covering and stacking, the soldering and cleaning operations are evaluated.

Solder alloys such as Sn60Pb40, Sn62Pb36Ag2, or Sn63Pb37 are acceptable according to J-STD-001. While on the other hand, high temperature solder alloys like Sn96.3Ag3.7 can only be used when it is specifically instructed by approved engineering drawings.

It is also important to note the significant differences in using Lead solder vs using Lead-Free Solder. Generally leaded solder is composed of tin and lead while lead free can be

composed of tin, copper, silver, nickel and zinc. Leaded solder is easier to use, has a lower melting point, a lower cost and will cause much fewer problems in quality with the joints than a lead-free solder. However, there have been efforts to remove lead out of all electronic products in the United States due to concerns about its health and environment effects. Lead-free solder's most important benefit lies in the fact that it is much safer however it falls short due to the fact that it tends to not have a stable melting temperature and its melting range is higher which can lead to damage of the electronic components.

### **4.1.2 PCB Standards**

Using printed circuit boards (PCB) is a way of removing or replacing the breadboarding aspect of project design. The Institute for Printed Circuits or Institute for Interconnecting and Packaging Electronic Circuits known as IPC is the organization most well known for producing PCB standards (33,34). IPC is known for producing standards for almost all phases of electronic design and development regarding PCB design, purchasing, packaging, and assembling. IPC standards are used for all electronic designers for references and customized project designs. IPC standards are used to determine manufacturing issues and what needs to be done to comply to meet said requirements.

A list of standards and qualified products is kept helping the project designer or design team to determine if the product is compliant with the IPC electrical design standards. PCB IPC standards are found in every stage of the PCB design and manufacturing process. For example, when a PCB is being designed and created, IPC sets standards in file formats, electronic product documentation, design guides, and PCB design software. PCB design requirements play a role in choosing appropriate material for PCB board design assemblies, surface finishes, surface mounted devices, testing, and quality or acceptability of the PCB board once printed.

Soldering standards also relate to IPC PCB especially for our project. In most cases the soldering standards refer to reflow soldering which we will need for our laser diode. Soldering standards are used to see if the electronic assemblies are deemed acceptable during the manufacturing process. IPC PCB standards are also used for cable and wire assemblies. IPC PCB standards are important for the manufacturing process, documentation, design guides, PCB software, as well as testing and inspection of electronic assemblies and enclosures to make sure the design is good for production before releasing a final product.

IPC design standards are important in producing a working product that is also safe and reliable. The details are essential when producing a high quality and high-performing PCB. Within each step of the design, assembly, and production process there's an IPC standard to be implemented. Companies must comply and use IPC PCB standards when promoting or producing a product to a company to be used and put on the market.

The most important thing about IPC PCB standards is to ensure that the product is quality and to keep catastrophic failures to an absolute minimum. Some added benefits of IPC PCB compliance standards include overall improved quality and reliability within products,

improved communication, cost reduction, and improved reputation to further your name and reliability.

Improving quality and reliability with a company's products will be more easily achieved by following IPC PCB standards during the manufacturing process. Abiding by IPC standards will ensure more consistent quality of products over time. Creating a product that is reliable and functions properly will lead to more profit, competition, consistency, and happier customers overall. Using the appropriate IPC standards will also improve communication within and outside of a company. Using the same IPC terminology will allow for more fluid communication to lessen confusion and to ensure everyone agrees.

Using IPC standards will make communication easier among employees within the company as well as the consumer or vendor. If everyone is familiar with the same terminology, it will lessen the confusion overall which leads to more consistent production and happier customers. Reducing cost is always a very important thing to consider in PCB and electronics design in general. Following IPC standards will help reduce cost by improving the quality of products and minimizing any delays. Using IPC standards will allow companies to use resources more efficiently to help reduce overall cost.

Improving reputation is important to allow for new opportunities to arise and to allow for more consumers to reach out to you. Immediately when you abide by IPC standards a company notices that which makes you more recognizable. Even when a company is smaller or not as well known, abiding by IPC standards shows that you are committed to quality. Abiding by IPC standards will attract more customers, allow for new opportunities, more profit, competition, consistency, and make the company more recognizable.

### ***4.1.3 Charging Standard***

Most versions of low power charging for smaller capacity batteries tend to be the safer option, however the 9.6V NiHM battery pack we have decided to move forward with comes with its own set of warnings. The battery pack chosen will power both the target board and the laser rifle and will be charged with the charging cable that is included. The NiMH battery pack comes with a fast charge that replenishes to 95% charge in supposedly a matter of 30 minutes.

Batteries of such capabilities tend to be designed exclusively for indoor use. The reason being that external environments and uncontrollable fluctuations in temperature can lead to overheating and damage to the charger. The charger should never be covered as well to avoid increases in internal temperature causing overall damage to the charger. In the instance of overheating and possible electrical issues the charger should also not be left on flammable surfaces.

The charger provided is a standard ac to dc conversion wall plug in. The common wall outlet voltage in homes and businesses is 120V and this supply can charge the 9.6V NiMH rechargeable battery using a driving output voltage of 7V (active low) DC to 12V (active high) DC and charging current of 2A to 3A. The provided charger can retrieve the



1600mAh within 35 minutes as opposed to the standard USB 3.0 wall charger which could take upwards of 5 hours to retrieve the same amount of power.

While it is important to be mindful to avoid overheating of the battery charger and battery pack, it is important to know that while the NiMH battery is charging it is normal for their temperature to increase substantially due to internal resistance. According to specification, most NiMH batteries may heat up to 55 degrees Celsius during a rapid charge. Therefore, it is important to allow the batteries to cool after charging before placing them within your equipment.

It is also said that before you use a new NiMH rechargeable battery pack you must charge them fully. For new NiMH batteries, it is often necessary to cycle them at least three to five times or more before they reach peak performance and capacity. The first several times that the NiMH batteries are used you may find that they discharge quickly during use, but that phenomenon is normal until the battery forms **(35)**. Therefore, it will be important to cycle the battery packs numerous times before we do any legitimate power testing.

#### ***4.1.4 Coding Standard - Programming Standard***

Computer languages evolve over time. For the programming language to be uniform and universally understood by engineers, programmers, compilers, or computers the language must be standardized. When we write a program, we need to ensure it compiles and does what it's supposed to. For that to happen, we need to write correct code. In this case, we use TypeScript as our programming language in the React Native for app development.

When we investigated the coding standards for React Native, we couldn't find any standards or practices provided by the community. But we found a web blog written by Gilsaan Jabbar with the title "React Native Coding Standards and Best Practices" (36). Therefore, we've decided to follow the guidelines written in that blog, and then write our own guidelines as well using the references from React Native documentation. We plan to follow as many of our own guidelines to create a more robust, readable, and clean code to make the code clearer for one of our teammates.

We have a few fundamental principles for creating a clear TypeScript source code. They are as follows:



1. Naming Conventions: A folder and subfolder name should always start with small letters and the file belongs to the folders in pascal case. The definition of “pascal case” comes from the programming convention and it describes when the first letter of each compound word in a variable is capitalized. For example, the company “ElectronicArt” or the video game “LeagueOfLegends”. To name the components we follow the pattern path-based component naming which may include writing the component accordingly to its relative path to the folder components or to app. For example, a Button component that is located at: components/common/Button.js would be named as Button.js.
2. Putting imports in order: React import, library imports in alphabetical order, Absolute imports from the project, Relative imports in alphabetical order, then Import \*as, and finally Import './<filename>.<extension>'. All of these are separated by an empty line.
3. Layout Conventions: Always end a statement with a “comma”. There are two types of data, State and Props in React native which control the component. The component that uses state is mutable which can be changed later if required. And when we use the State Hook, we should use a functional component. Indentation by one tab if the continuation lines are not automatically indented. There should be no line space between two similar looking statements.
4. Language Guidelines: *Data type* is a variable in React Native can contain any data. The *number type* represents both integer and floating point numbers. The *string type* is a type in React native must be surrounded by a single quote or double quotes. The *Boolean type* has two values: true and *false*. It can also represent yes/no values. There are more variables that are too much to include but they have been enough for us to be understood by everyone in the group.

There are a few more guidelines that we should include for code organization and code structure but there are enough details that we think are good enough for everyone to be understood by the group members. All of the details are too much to include in this section in this summary.

### **4.1.5 Documentation Standard**

This standard provides the guidance for the development and determines what is the requirement for the project to satisfy some provisions. The documentation standard is one of the established ways of doing things that ensure interoperability. Since the documentation is a technical report that explains our team design professionally, it is important that we should conform our current document to the current class project documentation guidelines.

For the document format, our written text needs to be a professional appearance, with a non-paper cover and bound. The length of the documentation needs to be one hundred

and twenty. Contents written in our document need to be relevant to our Laser Target Shooting project. Also, according to the class guidelines, the document cannot contain any programming code, no debug window screenshot, no images of common electronic parts such as transformer, HDMI, USB, transistor, or resistor. Combination of all images of some forms of testing should not be more than one or two printed pages. All data sheet material should be limited to two printed pages.

Then, our paper size must be 8.5" x 11", with 1" margins on the top, right, and bottom of each page. When it comes to the use of copyrighted content, the appendix in the document needs to contain written authorization for rights to include. Next, all elements of the document which support the written text, such as figures, tables, drawings, code segments, etc. must be referenced in the body of the text and the citation must appear before the element is shown. And finally, any supplementary material must be attached along with the current document. These are all the guidelines that our Laser Target Shooting project documentation must follow.

## **4.2 Constraints**

Constraints are required to be acknowledged because we cannot have our project design to be unreachable or not operate safely. As explained before, constraints consist of several categories for our intended product. Since we are working with lasers, which have a high performance, we must have constraints to limit the power of the product to some degree to meet the legal standards, ethical standards, and also power standards.

### **4.2.1 Laser Safety Constraints**

For our product to be successful, our laser should be powerful enough to perform well at long ranges. However, the laser also needs to be eye safe. Lasers are separated into a plethora of classes based on the output power and their visibility. Class 3R is from lasers 1 to 5mW, which is where our system falls under.

The main safety concern with class 3R is the visibility of the light. Class 3R lasers are considered safe if handled properly. Unlike Class 2 lasers, they are not considered eye safe if you accidentally look at the beam because they can cause damage faster than the eye can blink to block the beam. If the light is visible, then the eye will immediately close and prevent further damage. However, if the light is infrared and not visible, then the beam will be more dangerous since the eye will be exposed to the laser beam without closing in response.

When considering the beam emitted from the system will be expanded, our laser is also much safer than lasers with smaller spot sizes because the power will be spread over a large area. To ensure safety and prevent accidental injury when using the rifle, there are a variety of safety mechanisms to prevent the laser rifle from being used. Two built-in ways include a software-based safety and a physical beam blocker. The software-based safety activates after depleting a magazine and will prevent the gun from firing, while the

beam blocker will go over the barrel of the gun and block the beam. We also considered another digital safety mechanism that could be controlled through the smartphone app.

### ***4.2.2 Sustainability Constraints***

Unlike real firearms, the laser rifle is quite sensitive as a system, and performance is heavily reliant on system alignment. From the consumer perspective, an invisible infrared laser that can only be seen using special equipment such as IR viewing cards, is a near impossible task. As such, user maintenance will be limited to simple battery changes like most commercial products. Our project is like most products in the market that work under the model of offering warranty to give complete replacements to broken products rather than fixing the broken products themselves.

Our project is also designed to run for over 4 hours, but this is only considering using the system in standard conditions. If our system is used in conditions that could potentially damage the electronics within the system such as rainy weather or extremely humid environments, there is no guarantee that the system will be able to continue running.

### ***4.2.3 Social, Ethical, and Environmental Constraints***

As the intention of our design is to look and feel realistic, our project may be used as a tool for or against gun rights. With a large split in opinion towards gun control, our product could be pushed or seen as a tool for instigating violence, while others may see it as a tool for safe firearm training or even a mere toy. With how common toy guns and Airsoft rifles are, our product may be put into the same category. Regardless, the rifle itself cannot be used as a firearm, so these may be unneeded concerns.

No ethical constraints have been found with the project. Given proper safety instructions, warnings, and documentation, the product will not be able to be used to harm people unless intentionally used to do so.

There are also few environmental concerns with our project. The end goal of the project is to improve over ballistic firearms by using lasers to reduce the amount of lead or plastic being released into the environment. In addition to the physical waste, guns also cause significant noise pollution. The only environmental impacts would be the production process. Electronics manufacturing may produce harmful waste such as lead solder that can negatively impact the environment or become a health hazard.

### ***4.2.4 FCC Regulation - CFR 47 Part 15 - Radio Wave Constraints***

The Code of Federal Regulations (CFR) has section 47 which concerns the topic of telecommunication, in this section there is subsection 15 which goes into the regulations of radio frequency devices. This subsection contains the regulations needed to be met for this project to be safe and legal for the wireless communication aspects. Our purpose of this project is to have a functioning prototype that will be compliant with FCC CFR47 Part 15 Subsection 23.

Part B of subsection 23 states "It is recognized that the individual builder of home-built equipment may not possess the means to perform the measurements for determining compliance with the regulations. In this case, the builder is expected to employ good engineering practices to meet the specified technical standards to the greatest extent practicable."

This provision will be discussed and kept in mind throughout the process of testing and experimenting of the final design. Part B of subsection 23 also states that all requirements in subsection 5 must be met. The key parts of subsection 5 that must be met are that this device must not produce harmful interference intentionally, unintentionally, or incidentally. The Laser Rifle must be able to be turned off if requested by a commission representative (37).

Our devices aren't capable of letting the user break violations of regulation. The design should not affect the environment or cause any air pollution. The design should use the lowest field strength that will not pollute the air space with unnecessary noise. The design should note that even if all compliances are met it is not possible to stop harmful interference under all circumstances.

The communication of the device will not invade any person's privacy or record any person communication. The device created must be engineered to be as minimally harmful as possible. Still following the FCC rule, the warning label must be permanent and not easily removed. The user manual for the device must state that if the user modifies the device in any way that is not expressly approved by the party in charge of compliance to the regulations the user can lose authority to operate the device.

#### ***4.2.5 Manufacturing Constraints***

There are two main factors that come into play when discussing manufacturing constraints. The first is the personnel working on the project. As our team consists of optical, electrical, and computer engineering students, our work in fields not related to our majors is not significantly in-depth or polished. As many of our designs rely on 3D printing, our designs may not be mechanically reliable or function as well as they could if a mechanical engineering student worked on these tasks. As a result, many of our mechanical designs would be considered amateur and we may rely on purchasing or using open source designs for 3D printed parts such as cooling fins for temperature control.

The second main factor is related to how we will assemble and gather our parts. Some of the components we used were surface mount components that are difficult to mount onto PCBs by hand especially when considering the complexity of the PCB designs. Without the proper equipment, such as reflow soldering ovens, we had to look into getting online manufacturers who can solder the components onto the PCBs for us. Otherwise, we risked damaging valuable components that may have to be repurchased, further delaying testing.

Aside from these two factors, the only other factor would be being unable to build our prototype due to not being able to get our parts. This could be caused by long shipping times or a scarcity of materials. The shipping times may be a problem for PCBs but we did not experience any problems with this.

#### **4.2.6 Time Constraints**

As there are only four members in the group while also having other classes and responsibilities, there is a limit on how much time we can spend working on the project. This can be burdensome especially since our schedules may conflict and limit when members can meet to discuss and work on the project together. Sudden design changes or ordering replacement parts that unexpectedly break down may not be viable due to long shipping times or backorders, which is an important element to consider given the deadlines.

We find that time constraints may be the most difficult constraint for our team and many other Senior Design teams. The project must be finished by the end of Senior Design 2 with a working prototype. Additionally, all of the main components making up the system needed to be finished before we began trying to implement any stretch goals.

#### **4.2.7 Economic Constraints**

Another major constraint with our project is the funding. As we were not sponsored by a company or other type of sponsor like other Senior Design groups, we had to pay for all of our parts out-of-pocket. As we are aiming to stay under a one thousand dollar cost, our project may have suffered from some performance issues due to substituting with cheaper parts, be it the construction of the project or the parts selected to use in the design itself.

There are also a limited amount of free tools available to us as students of UCF. While the Senior Design labs have a good amount of equipment for testing and prototype construction, some equipment and programs needed may be unavailable unless we pay out of pocket.

## **5.0 Project Hardware and Software Design Details**

This section discusses the various design elements contained within the laser rifle and target board systems. Split into hardware and software, this section contains details regarding electrical schematics, optical designs, and software developed for use in our project.

### **5.1 Hardware: Optical Designs**

In this section, the various optical designs used in our project's systems will be described. This section includes details about the main optical designs such as the rifle scope, beam expander, IR flashlight, and even includes details about designs for stretch goals.

### **5.1.1 Beam Collimator**

For our system, a beam collimator may be needed despite the laser diode having a preinstalled collimator lens. This was not an issue in the final design, but we found through testing that the output from the IR diode can change optical properties depending on how high quality of a solder we make, so the laser diode output could potentially not be collimated. As a result, we will include information about a beam collimator since we had designed for one in the worst-case scenario.

For the collimator lens, there are two main parameters that need to be considered. One is the focal length of the lens. For light acting like a point source, the physical size of the source plays a role in the output divergence angle when collimated. The divergence angle outputted by a collimator when placed a focal length away from the source is equivalent to the size of the source divided by the focal length of the collimating lens.

As such, the larger the focal length and the smaller the source, the smaller the divergence angle of the collimated beam. In a typical laser diode, there would be concerns about the difference in divergence angle between the fast and slow axis, but for our project, this is not a concern. Not only do we not need a specific beam profile, but we are also using VCSEL diodes that emit highly circular beams where there is little to no astigmatism.

The second main factor is the diameter of the lens. Since the light source will be expanding in size as it travels to the collimating lens, the collimating lens needs to be physically large enough to capture all of the diverging light. This is directly related to the focal length since the lens needs to be placed a focal length away from the light source. In summary, a larger focal length collimating lens allows for a smaller collimated divergence angle, however, this means that the beam itself will become larger.

As a result, there must be a balance between these two parameters. Fortunately, since we are using a beam expander that will yield a similar effect, there is room for freedom when it comes to the selection of this lens.

### **5.1.2 Beam Expander**

As mentioned previously, the beam expander plays an important role. There are two main kinds of beam expanders: Keplerian and Galilean. In a Keplerian expander, two convex lenses are placed at a distance equal to the sum of their focal lengths. In a Galilean expander, a concave lens and convex lens are used instead. The difference between these two types of expanders is shown in **Figure 8**. Due to the use of concave lenses, Galilean expanders have several differences from Keplerian expanders.

Since the beam never converges to a point, the beam outputted by the Galilean expander is not inverted like it is in a Keplerian expander. However, this feature does not matter for our project since the shape of the output beam is not of massive importance. The main feature is the compactness of the design.



Since concave lenses have negative focal lengths and the distance between the two lenses is equal to the sum of the focal lengths for both types of beam expanders, Galilean expanders can be made to be much shorter than Keplerian designs. In our system where the amount of space is limited, this is an important design choice to take into consideration.

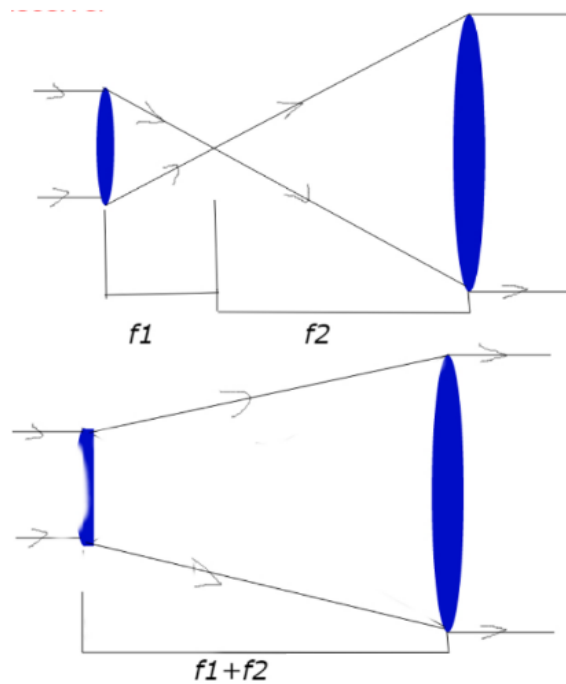

**Figure 8. Keplerian and Galilean Beam Expander**

Mathematically, beam expanders provide an effect similar to that of the collimating lens. The magnification ratio is equal to the focal length of the second lens divided by the focal length of the first lens. This means that for expanding a beam, a short focal length lens is used as the first lens while a longer focal length lens is used as the second lens.

Additionally, the ratio between the divergence angle of the expanded beam to the input beam is equal to the focal length of the first lens divided by the focal length of the second lens. Regardless of what type of beam expander is used, these relationships are maintained in both systems. This means that, just like in the collimating lens, to have a smaller beam divergence, the beam must be expanded to a larger size.

To meet the divergence angle requirement, our beam expander used a Galilean design with a 25mm focal length biconcave lens and 200mm focal length plano convex lens. This is equivalent to a 8x size magnification as well as a reduction in divergence angle by 87.5%. These lenses were selected based on the values provided in the datasheet for



the IR diode, where the divergence angle was given as  $<10$  mrad and the collimated beam diameter was given as 3mm.

Depending on how close the beam expander is to the diode, after passing through the beam expander, this would result in an, at minimum, 24mm diameter beam with a 1.25 mrad divergence angle. This will be quite large after propagating over 15m, so we added the option to implement an aperture to decrease beam size if necessary.

### ***5.1.3 Target Board Lens System***

For this system, there were many different designs that were considered. Ultimately, the goal for this system is to reduce the number of receivers needed. Using an upscaled version of a microlens array was also considered, but due to the size of our target board, we found that making the surface of the board itself into a lens is significantly more cost-effective and more versatile for different types of designs.

Initially, since we were considering using photodiodes at first, convex lenses are what we considered as a valid option. Since photodiodes require a substantial amount of optical power to produce noticeable current (which would later have to be amplified using an amplification circuit), a convex lens would solve two problems by focusing the laser light onto a smaller area, resulting in a need for less photodiodes spread out in an area, while also increasing the intensity of the beam.

However, this idea has its flaws. Since the lens is focusing the light, the angle and position where the light strikes the surface of the lens will affect the output spot position. This means that we will still need a quite large number of photodiodes to cover the potential areas and angles where one could fire the laser at. Additionally, since we moved away from photodiodes and towards IR receivers that require very little optical power to output a digital signal, we moved towards concave lenses.

Concave lenses will spread the incoming light to a much larger area, significantly reducing the amount of receivers needed at the cost of intensity. However, since the light needs to travel over a distance to become larger, and the distance between front surface of the target board and the receivers will only be 35mm, this could still require a moderate number of receivers for the largest target areas. Ideally, we would only need one receiver per target area.

This is when we considered using a light diffuser combined with a concave lens. A light diffuser is a translucent object that works by scattering the incoming light and spreads it over a larger area. These are often used in LEDs to increase their viewing angle. Since PETG 3D printed objects are translucent without any post-processing, diffusers are very simple to make using a 3D printer.

Fortunately, since our IR laser is quite powerful and IR receivers take extremely little optical power to activate, the laser beam that exits a diffuser and a concave lens will still

be strong enough to activate the receiver. Essentially, the diffuser will expand the beam through scattering and then the concave lens will expand that light even further.

In **Figure 9**, this idea was tested to see if it was a valid technique. In this figure, we show the size of a 1mm diameter laser beam passing through a diffuser (a simple 1mm thick 3D printed PETG disk with no post-processing) and a -30mm EFL biconcave lens. In the diffuser and lens combination, the diffuser plate is held close to the front surface of the concave lens. This combination clearly outputs a much larger beam than the two used separately.

The diffuser plate also has a large amount of reflections on the surface as well as attenuation from transmitting through the plate. With the decrease in optical intensity from the lens and the transmission losses from the diffuser, optical noise will be significantly decreased using this method.

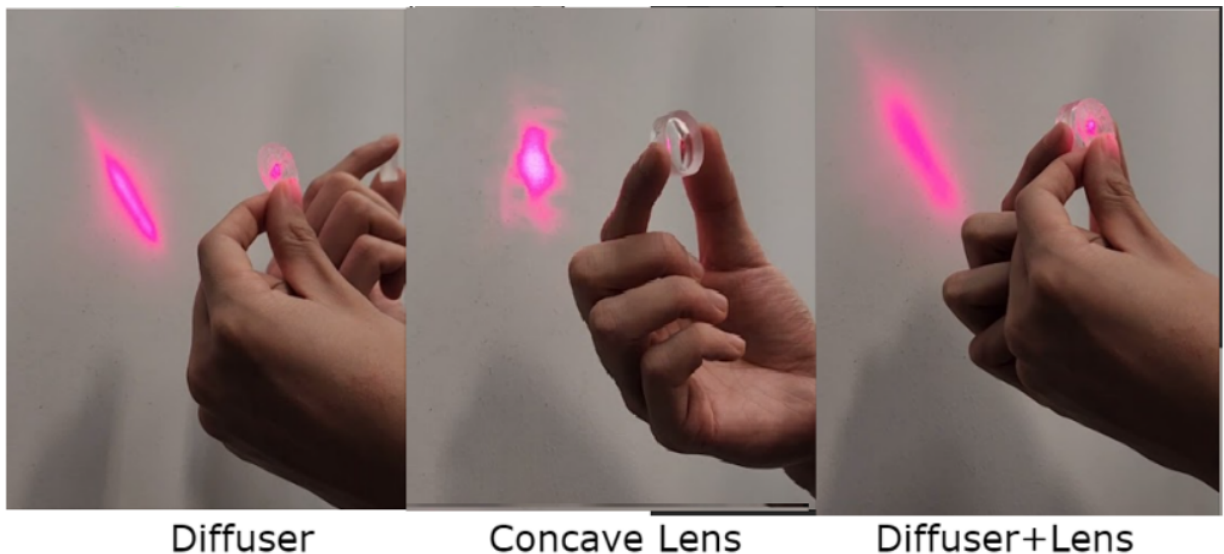

**Figure 9. Diffuser and Concave Lens Proof of Concept**

The lenses were plano concave lenses with a radius of curvature that is 1.2x the radius of the lens. For a plano convex or plano concave lens, the focal length of the lens is double the radius of curvature. Ideally, the lenses would have a focal length as short as possible to increase the beam diameter as much as possible, but this means that the lenses would become very thick as the diameter of the lens increases, making for a much bulkier target board. Aside from the plano concave design choice, there is also the choice of doing a biconcave design to increase the power of the lens further, but this too would lead to a thick design that will also be very difficult to 3D print. This is due to the lens not having a flat base that lays flat on the hotbed of the 3D printer.

The reason we chose a radius of curvature that is proportional to the size of the lens rather than using one that is fixed (i.e., 50mm) is because we have a variety of lens sizes in the target board. For smaller lenses that only have a 12.7mm radius, having a 50mm radius of curvature would be wasteful since smaller lenses can have much shorter focal lengths without becoming extremely thick. In **Figure 10**, the 3D model design for the 50mm diameter lens used in our target board is shown. The radius of curvature is 1.2x the radius of the lens, so it has a 30mm radius of curvature with a total thickness of 18mm.

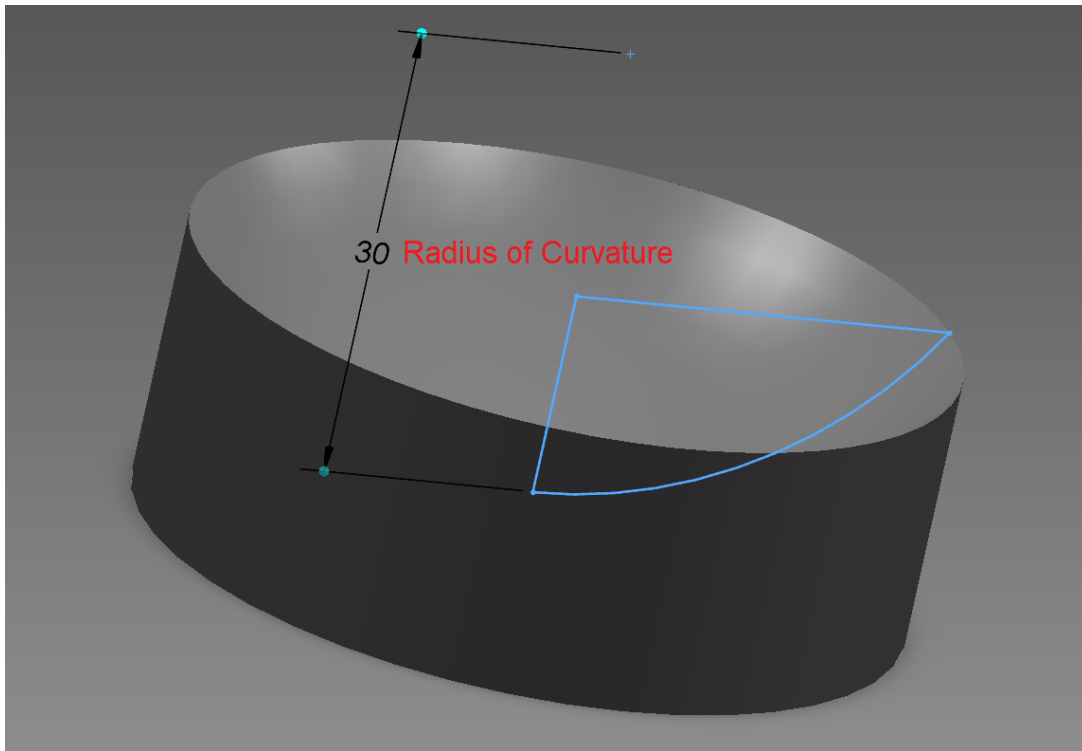

**Figure 10. 50mm Diameter Plano Concave Lens 3D Model**

We also provide a Zemax simulation for the same lens in **Figure 11** to understand how effective the lens is at expanding the beam in the 35mm space available. The lens data inputted into Zemax is shown in **Table 5**. The lens was evaluated at a 940 nm with an input 40mm collimated beam going into the system. We input different values for the field angles to determine the maximum angle that can be accepted into the system and still strike the surface of the IR receiver. We did this because we needed to make sure that the system can be used for off-axis angles that allow for a more versatile target system. We got 40 degrees as the maximum angle, meaning that a user can shoot at the target from a 40-degree angle and the IR receiver will still be able to catch the laser light.

The refractive index of the lens was inputted at 1.57, as this is the refractive index of PETG. From the ray diagram, a 40mm spot size beam (the maximum spot size set in our design requirements) striking the center of the lens will more than double in size,

expanding to a 86mm beam. According to Zemax, the effective focal length of the lens is -52.6mm. With the inclusion of a diffusion plate, the output beam will become even larger and allow for even larger incoming angles. We provide images of our tests using this lens in the test section.

Surface Type	Comment	Radius	Thickness	Material	Coating	Clear Semi-Dia	Chip Zone	Mech Semi-Dia
0 OBJECT Standard ▾		Infinity	Infinity			0.000	0.000	0.000
1 STOP Standard ▾		-30.000	2.000	1.57,0.0 M		25.000	0.000	25.000 U
2 Standard ▾		Infinity	35.000			31.988	0.000	31.988
3 IMAGE Standard ▾		Infinity	-			61.780	0.000	61.780

Table 5. 50mm Diameter PETG Lens Data

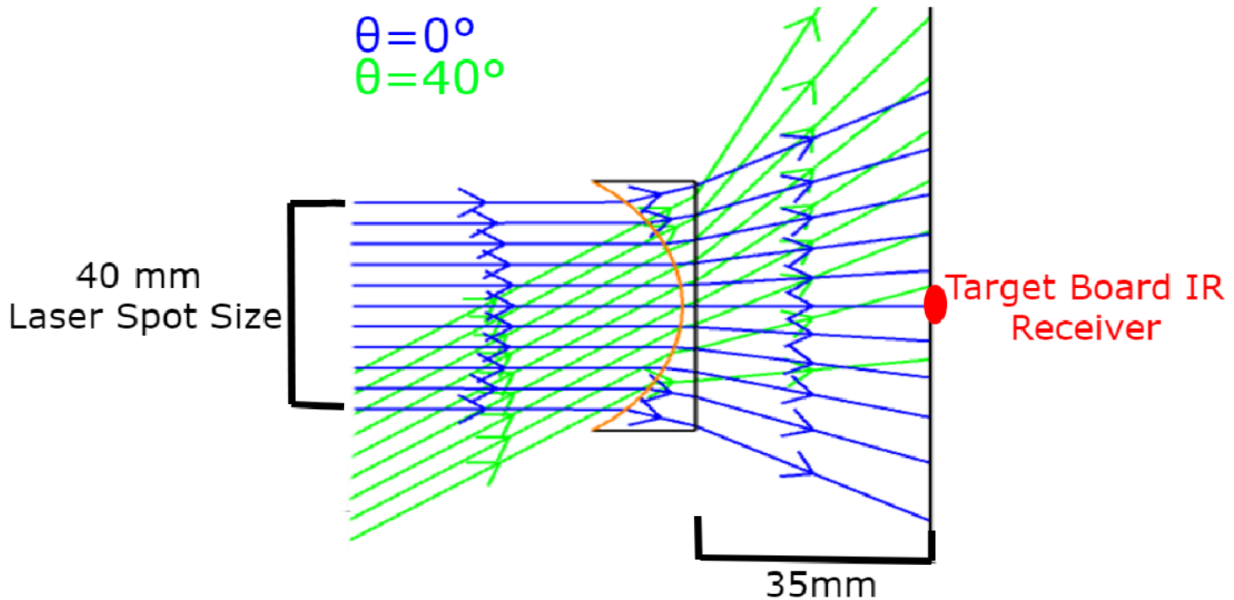

Figure 11. 50mm Diameter PETG Lens Diagram

### 5.1.4 Variable Power Rifle Scope

In rifle scopes, there are many variables that need to be considered. A rifle scope is like a basic telescope design where it has an objective lens assembly and an eyepiece lens assembly where the image is output for viewing. However, rifle scopes also have an erector assembly that, since the image coming from the objective lens becomes inverted, is used to erect, or flip, the image back to its original orientation. The erector assembly is typically a telescoping lens tube that can move back and forward in variable power scope systems. The reticle can either be mounted in front or behind the erector lens assembly.

Regarding the reticle placement, there is a difference between being located at the first focal plane (FFP) and second focal plane (SFP). In an FFP scope, the reticle is located at the first focal plane, while it is located at the second focal plane in an SFP scope. The main difference between the two types relates to the magnification of the reticle image itself. In an FFP scope, the reticle grows as the magnification of the scope is increased. In an SFP scope, the reticle stays at a static size regardless of how the magnification is changed. For our project, we will use an FFP system so that parallax, described in more detail below, is easier to correct.

In rifle scopes, there is also an optical effect called parallax. Parallax can be observed when the user looks through the scope at oblique angles. This effect is caused when the light coming through the system is not properly focused onto the reticle. In a scope, parallax manifests itself as a shifting of the reticle. When the user looks through the scope at different angles or positions, the reticle moves with the user's head movements rather than staying at a fixed position. In **Figure 12 (38)**, this effect is illustrated. In a system without parallax, the star object in the figure would always be on the white box no matter what viewpoint you look from.

There are several ways to deal with parallax in scopes. The first method is to introduce an adjustable objective (AO) system. Essentially, a dial is installed onto the holder for the objective lens and when turned, the objective lens will move back and forward so that the focus can be moved back onto the reticle. Another method is using a side focus. A side focus introduces a new lens in between the first focal plane and the objective lens. A side focus dial is used to shift this lens back and forward for the same effect as an AO system. For our project, we used a side focus system because the scope was quite long, meaning that adjusting the position of the objective while holding the rifle will be difficult and uncomfortable for the user.

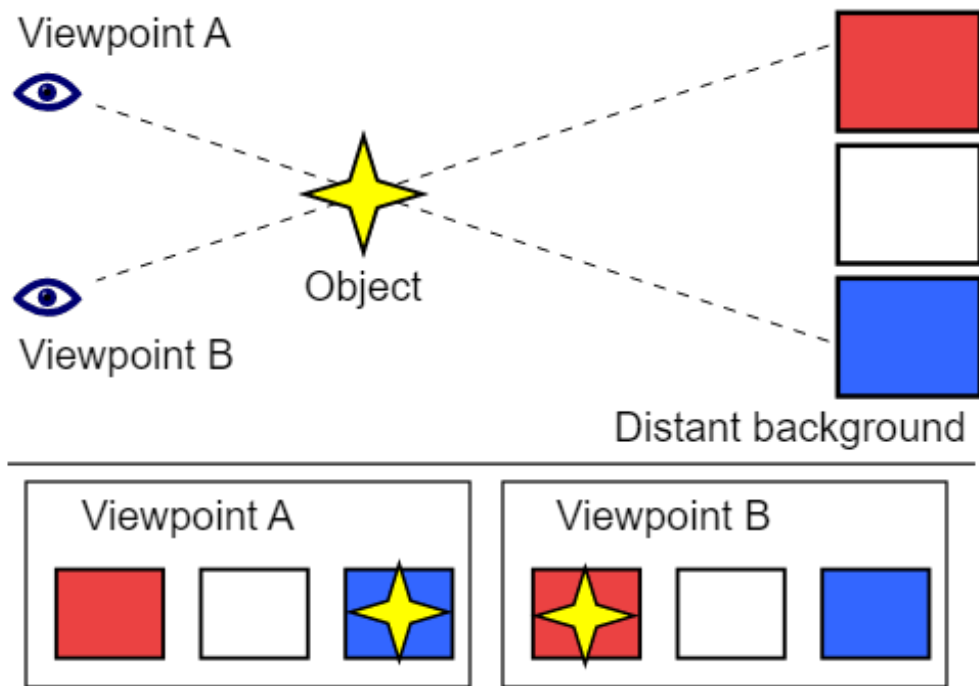

**Figure 12. Parallax Error**

For the lenses used, there are many system variables to be considered. Starting with the objective, this lens assembly must contain large diameter lenses with a longer effective focal length. The objective is the lens capturing all the light, so it will need to have a large diameter for a higher resolution image.

However, since many optical aberrations scale with the physical size of lenses and the length of the scope cannot be extremely long, some trade offs will need to be made. One example is increasing magnification at the cost of more aberrations and decreasing the diameter of the aperture stop to balance for these aberrations.

We must also consider the resolution of the image. Since we have specified our target angular resolution as at least 0.15 mrad, we must also consider that the numerical aperture of the system must be large enough to meet these requirements. An optical system is considered high quality if the angular resolution is equivalent to the angular resolution limit of the human eye (0.3 mrad) divided by the angular magnification (39).

For our 4x magnification scope, this would be a .075 mrad angular resolution. For a 15m target, this is equivalent to an object that is only 1.125mm large. Realistically, there is no realistic application in a rifle scope that would require you to be able to resolve something of this size at such a large distance away, but ideally, we would like to be able to achieve this resolution. However, this would be difficult to get to such a high resolution. The scope

would need to be a fairly large numerical aperture system that also has low amounts of optical aberration in the image, meaning expensive lenses will be required.

Regarding the image outputted by the scope, the parameters for the exit pupil are important. For most eyepieces used in optical systems, the exit pupil diameter is designed so that it is roughly the same size as the human eye. Exit pupil diameter is simply the entrance pupil diameter divided by the magnification of the system. The pupil of the human eye can change from 2mm to 8mm depending on the lighting conditions, with 2mm being in the brightest conditions and 8mm in dark conditions.

The exit pupil diameter determines how bright the image will appear to the human eye. If the exit pupil is significantly larger than the pupil of the eye, then most of the light will not be captured by the eye's pupil due to its size. Therefore, when compared to a system where the exit pupil perfectly matches the pupil of the eye in diameter, the brightness will be perceived as the exact same. However, if the pupil of the eye is much larger than the exit pupil, then the image will be perceived as dark.

We designed our exit pupil so that it is around 10mm in size. Although some light will be wasted, this is to increase the amount of leeway the user has when aiming. If the exit pupil is exactly the size of your pupil, then your eye has to be positioned exactly at the position of the exit pupil to get the brightest image possible, which is not realistic for a highly portable system like a rifle.

Additionally, there is also the eye relief, or the distance from the exit pupil to the eyepiece lens assembly. The image is best when the user's eye is located directly at the exit pupil. Naturally, the eye relief needs to be a realistic distance such that a user can easily use the scope without being too far or close to the lens. Binocular systems normally use around 15mm eye reliefs, but for rifle scopes, these are typically around 50mm to 100mm depending on the magnification. This is because rifles have recoil when firing and the impact can cause the scope to injure a user if the eye relief is too short (40).

Aside from this, using a longer eye relief is useful because the eye relief will shift position as the magnification of the scope is changed. This also accounts for people wearing eyeglasses or safety goggles who cannot put their head too close to the lens. For our scope, we planned on using an eye relief that is around 60mm to follow this standard. It is also important to note that the light emitted from the scope must be collimated. This is to reduce the eye strain on the user when looking through the scope for extended periods of time.

Naturally, this also means that other parameters such as the resolution, aberrations, etc will change as the lens moves. As such, we chose to optimize the system for a single magnification level, prioritizing resolution, and the collimation of the light at this magnification while other magnifications are of less priority. Ultimately, we decided to design towards a 4x magnification for an optimal picture since 4x is a common magnification used in scopes on the market.

The rifle scope system consists of 6 total lenses of which the Zemax lens data is provided in **Table 6** below. **Figure 13** shows the layout of the entire scope system along with



information about the exit pupil. The blue rays are at a field angle of 0 degrees, green at 1.5 degrees, and red at 2 degrees. The evaluated wavelengths included the F, d, and C lines (486 nm, 588 nm, and 656 nm respectively) as well as 860 nm. It is vital that we evaluate performance at 860 nm in the design process since the rifle will need to be used with the IR flashlight for night vision.

This scope system is our second design iteration and includes more expensive lenses such as achromats that are designed to correct for aberrations, increase image resolution, as well as shrink the overall length of the system, which were the main problems with our original design. We chose to do this because our original design did not meet the resolution requirement, we set in our Design Specifications.

In the Zemax lens data table below, we have labeled what each surface is. At Surface 18, you can see that the exit pupil is labeled. The distance between Surface 17 and Surface 18 is the eye relief distance. In the Clear Semi-Dia column, the aperture size of each surface is listed. For the exit pupil, the radius of the exit pupil is listed in this column.

Surface	Surface Type	Commen	Radius	Thickness	Material	Coating	Clear Semi-Dia	Mech Semi-Dia
0	OBJECT Standard ▾		Infinity	Infinity			Infinity	Infinity
1	(aper) Standard ▾	Objective	74.852	5.000	H-ZBAF21		30.000 U	30.000
2	(aper) Standard ▾		36.426	16.500	H-ZK1		28.000 U	28.000 U
3	(aper) Standard ▾		-292.5...	78.339 V			28.000 U	28.000 U
4	(aper) Standard ▾	#45-515	90.470	3.500	N-BK7	EO_VISNIR_517	12.000 U	12.500
5	(aper) Standard ▾		Infinity	70.286 V		EO_VISNIR_517	12.000 U	12.500
6	(aper) Standard ▾	PAC358	89.358	1.500	SF8		9.000 U	9.000
7	(aper) Standard ▾		22.470	4.460	SK11		9.000 U	9.000
8	(aper) Standard ▾		-32.160	24.000			9.000 U	9.000
9	STOP Standard ▾		Infinity	0.000			8.500 U	8.500
10	(aper) Standard ▾	PAC358	32.160	4.460	SK11		9.000 U	9.000
11	(aper) Standard ▾		-22.470	1.500	SF8		9.000 U	9.000
12	(aper) Standard ▾		-89.358	102.101 V			9.000 U	9.000
13	(aper) Standard ▾	#32323	214.630	2.500	N-SF10	EO_MGF2(550nm)	12.000 U	12.500
14	(aper) Standard ▾		21.980	9.000	N-BAF10		12.000 U	12.500
15	(aper) Standard ▾		-34.530	10.000		EO_MGF2(550nm)	12.000 U	12.500
16	(aper) Standard ▾	KPX108	116.712	3.693	BK7		12.700 U	12.700
17	(aper) Standard ▾		Infinity	56.501 U			12.700 U	12.700
18	Standard ▾	Exit Pupil	Infinity	0.000			5.230	5.230
19	IMAGE Standard ▾		Infinity	-			5.230	5.230

**Table 6. Rifle Scope Lens Data**

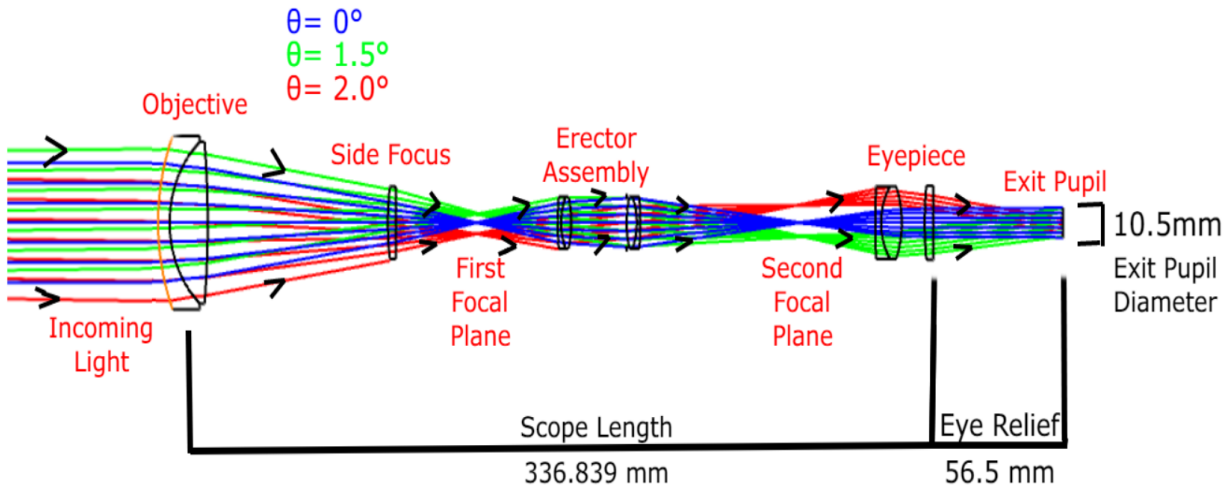

**Figure 13. Rifle Scope Lens Layout**

The objective lens is a 60mm diameter achromat lens coated with an  $\text{MgF}_2$  anti reflection coating that reduces reflections from 400-700 nm to as low as 0.4%. This is a custom achromat that we acquired off eBay that came with a datasheet for the lens. Using a large aperture for the objective captures lighter, allowing for a higher resolution image. This was originally a Plano convex lens in our original design, but we changed it into this achromat to induce a large amount of negative spherical aberration that can be used to correct for the system aberrations.

The second lens is the Edmund Optics #45-895, a biconvex lens that is used as the side focus lens for parallax correction. This lens has a 25.4mm diameter and is coated with Edmund Optic's VIS-NIR coating, a visible and near infrared visible AR coating that reflects less than 1.25% of light from 400-1000 nm.

The lenses making up the erector assembly are two Newport PAC358 18mm diameter double achromats. The doublet achromats work to correct some of the spherical aberration and chromatic aberration in the system. The aperture stop of the scope system is located at the front surface of the second achromat.

Due to the physical size of the achromats, the amount of light exiting the system and numerical aperture is limited, but this also plays an important role by significantly reducing the number of optical aberrations. These lenses are coated with single layer  $\text{MgF}_2$  anti reflection coatings that reduce reflections from 400-700 nm such that reflections are, on average, less than 1.5%.

Finally, the eyepiece consists of the Edmund Optics #32-323 double achromat 25mm diameter lens followed by the Newport KPX108-C 25.4mm diameter plano convex lens which are both coated with  $\text{MgF}_2$  AR coatings. The eyepiece is important for characterizing the exit pupil of the system as well as the output magnification.

Originally, we used a biconvex lens combined with a plano convex lens as the eyepiece, but we improved our design by using a Kellner eyepiece with an achromat and plano convex lens. Using this eyepiece decreases the amount of image distortion while also correcting some chromatic aberrations. Overall, when combining all of the lenses in the system, the total amount of light transmission is calculated to be around 80% for 650 nm light with 860 nm light being near 75%.

Overall, this scope is improved over our past design and meets the design specifications as discussed earlier. First, the effective focal length of the system is 19m, meaning that the system emits collimated light. The total length of the system is also 336mm long, which is a quite standard length when it comes to rifle scopes. In comparison, our previous design was very long at 485mm in length and had significantly more aberrations.

The parameters surrounding the exit pupil of the rifle scope are also good. The eye relief and exit pupil diameter, 56.5 mm and 10.5 mm respectively, are quite good for use in a rifle scope as described before. Since the magnification will be adjustable, the eye relief and exit pupil diameter will decrease as the magnification is increased and vice versa.

We also significantly improved on aberration correction as shown in **Figure 14**. Note that the chromatic aberration of the system is relatively high despite there being so many achromats in the system. This is because we included 860 nm as one of the evaluated wavelengths while also including the standard RGB wavelengths.

The distortion is also quite high, but this actually works in our favor when using the camera as it will correct some of the distortion. This is explored in more detail in the section describing the design for the camera lens system. Due to the overall decrease in aberrations, the image resolution is significantly improved over past designs and is closer to the diffraction limit for on-axis rays.

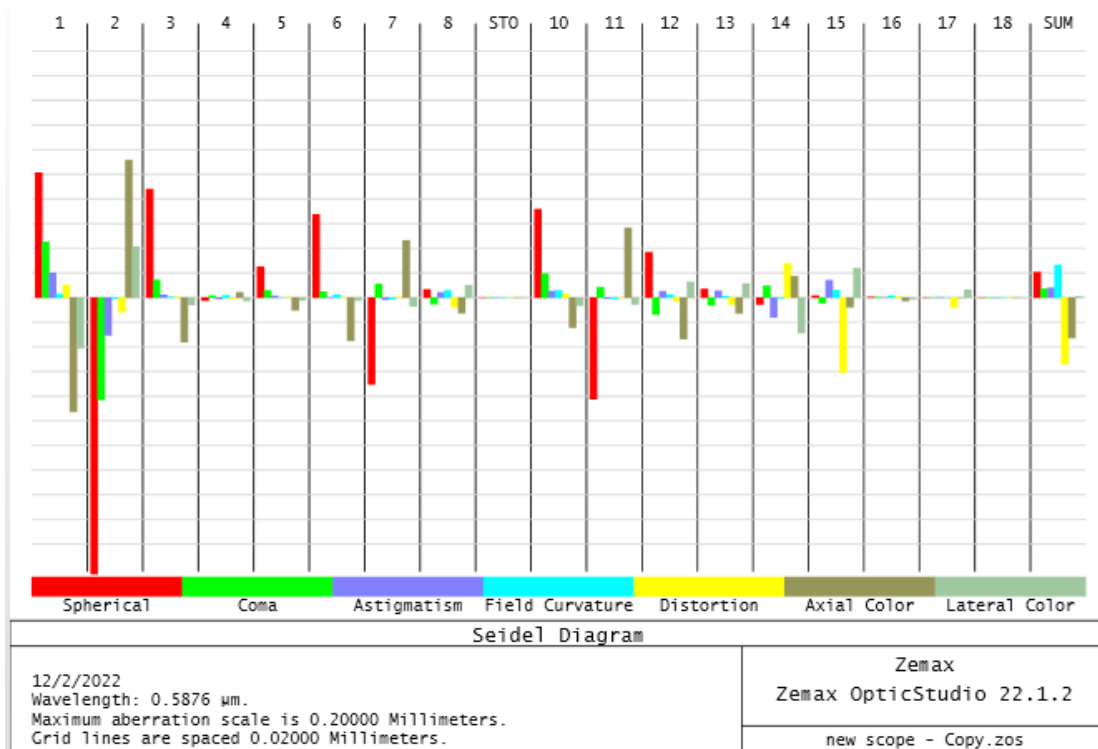

**Figure 14. Rifle Scope Aberrations Chart**

The MTF, which provides information about the resolving power of the scope, is shown in **Figure 15**. For practical purposes, the resolution limit of a system is when the MTF is approximately equal to 0.1. For our system, the MTF is equal to 0.1 at 8 cycles per mrad. This is equivalent to an angular resolution of 0.125 mrad and meets our design requirements for resolution. Although, this is only possible for light that is coming into the system axially, while other angles have worse performance.

To improve the resolution, we would need to increase the numerical aperture of the system. At the moment, the aperture stop of the system is limited by the size of the achromats used in the erector assembly (18mm diameter), so we could increase resolution with the use of larger lenses by getting lenses if the aberrations introduced by a larger aperture are properly corrected.

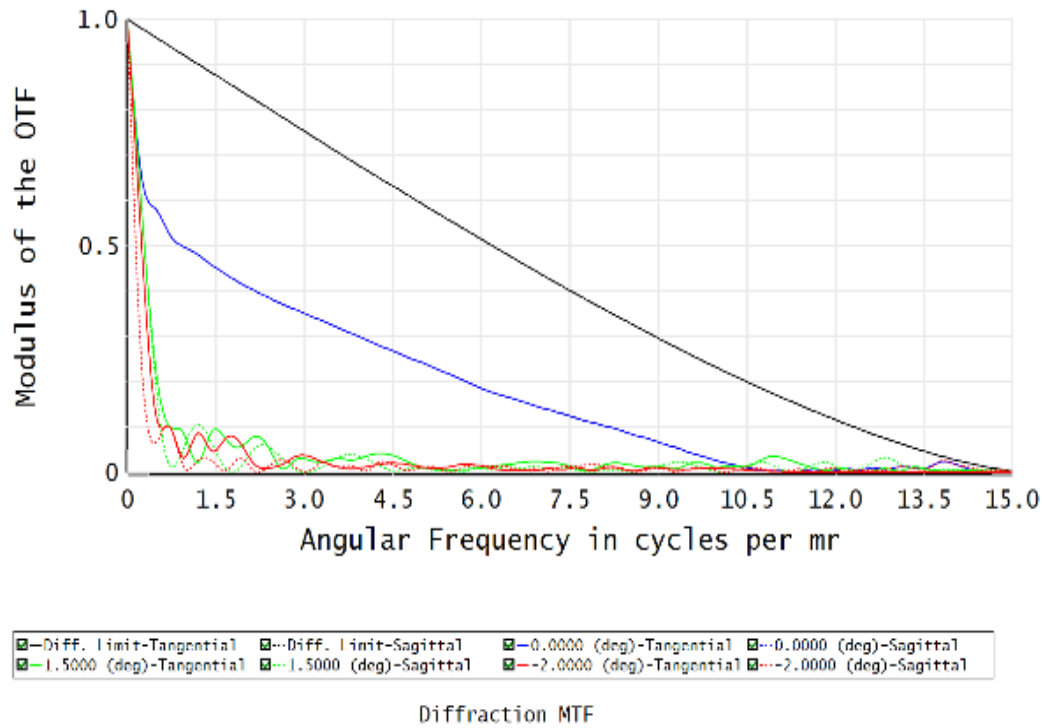

**Figure 15. MTF of Rifle Scope**

### 5.1.5 CMOS Camera Lens System

The main purpose for this system is to alter the field of view of the camera we purchase. Since we used a wide-angle camera with a 170 degree field of view, we will need to shrink this field of view such that more of the image of the camera is looking through the scope. Since the built-in camera lens will not be removable, the most appropriate way to accomplish this is through a magnifying lens system that will magnify the view through the scope. With the right design, this increases the resolving power of the camera while also shrinking the field of view for a size that is more suitable for our system.

To design this system, we first designed for the desired field of view. The field of view is the angle that the chief ray exits the system in object space. Since we know nothing about the lens system built into the camera itself, we simplified the system to an optical “black box” where the output field of view is 170 degrees. For simulation purposes, this means that we would effectively treat the system as a point source emitting at a 170-degree cone angle. The way we approached the lens system design was to take the ray emitting at the most extreme FOV half angle (85 degrees) and bend the ray angle using the lens system to get the desired field of view.

We can also consider how the rifle scope system will interact with the wide-angle lens system. Generally, wide angle lenses have a large number of chromatic aberrations and

distortion, however, considering this system will primarily be designed for night vision with use in daylight being secondary in terms of priority, we will only need to worry about distortion. This is because the 860nm LED, although it will have a relatively large spectrum at around 75 nm, most of the light intensity will be centered around the peak wavelength meaning that chromatic aberration will not be as noticeable. From our tests, we have determined that the camera system has positive distortion, which is convenient for us because the rifle scope already outputs an image with negative distortion as described before.

Unfortunately, since the initial field of view of the camera is so large, it is difficult to get a smaller field of view while also having a usable picture since there will be a large amount of aberration that will be introduced when bending the rays. Due to the unknown properties of the wide angle lens built into the camera, this design requires in depth testing to make sure the system actually works with the camera outside of theory. We have actually made and tested a couple of different lens systems, but only the one we have selected to have the best results will be discussed.

For the lens system, we used the Edmund Optics VIS-NIR coated #45-887 and #45-930 25.4mm biconvex and biconcave lenses, which have a 25mm and -25mm effective focal length respectively. By using a negative lens combined with a positive lens, the amount of aberration in the system is significantly reduced while a short focal length is maintained. To analyze our design, rather than viewing the camera lens system by itself, we chose to put it into the scope design as shown in **Figure 16** and evaluated the aberrations that the lens system has when put into this system. We also include the Zemax data for the camera lens system in **Table 7**.

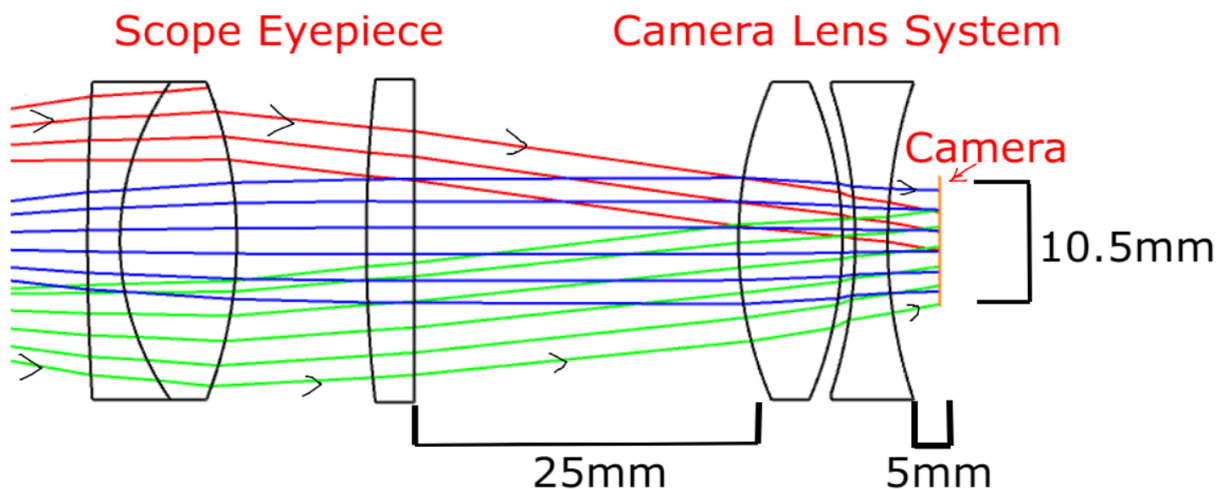

**Figure 16. Camera-Scope System Layout**

	Surface Type	Commen	Radius	Thickness	Material	Coating	Semi-Diameter	Mech Semi-Dia
0	OBJECT Standard ▾		Infinity	Infinity			Infinity	Infinity
1	(aper) Standard ▾		74.852	5.000	H-ZBAF21		30.000 U	30.000
2	(aper) Standard ▾		36.426	16.500	H-ZK1		28.000 U	28.000 U
3	(aper) Standard ▾	Objective	-292.5...	78.339 V			28.000 U	28.000 U
4	(aper) Standard ▾	#45-515	90.470	3.500	N-BK7	EO_VISNIR_517	12.000 U	12.500
5	(aper) Standard ▾		Infinity	70.286 V		EO_VISNIR_517	12.000 U	12.500
6	(aper) Standard ▾		89.358	1.500	SF8		9.000 U	9.000
7	(aper) Standard ▾		22.470	4.460	SK11		9.000 U	9.000
8	(aper) Standard ▾	PAC358	-32.160	24.000			9.000 U	9.000
9	STOP Standard ▾		Infinity	0.000			8.500 U	8.500
10	(aper) Standard ▾	PAC358	32.160	4.460	SK11		9.000 U	9.000
11	(aper) Standard ▾		-22.470	1.500	SF8		9.000 U	9.000
12	(aper) Standard ▾		-89.358	102.101 V			9.000 U	9.000
13	(aper) Standard ▾		214.630	2.500	N-SF10	EO_MGF2(550nm)	12.000 U	12.500
14	(aper) Standard ▾		21.980	9.000	N-BAF10		12.000 U	12.500
15	(aper) Standard ▾	#32323	-34.530	10.000		EO_MGF2(550nm)	12.000 U	12.500
16	(aper) Standard ▾	KPX108	116.712	3.693	BK7		12.700 U	12.700
17	(aper) Standard ▾		Infinity	25.000			12.700 U	12.700
18	<b>Camera Lens System</b>	#45-887	31.940	8.000	N-SF5	EO_VISNIR_673	12.000 U	12.500
19			-31.940	1.000		EO_VISNIR_673	12.000 U	12.500
20		#45-930	-39.780	2.500	N-SF11	EO_VISNIR_785	12.000 U	12.500
21			39.780	5.000		EO_VISNIR_785	12.000 U	12.500
22	IMAGE Standard ▾		Infinity	-			5.635	5.635

**Table 7. Camera-Scope System Lens Data**

The concave lens introduces a large amount of negative aberration as shown in **Figure 17**. The overall aberrations introduced by the camera lens system is generally low. Additionally, since the wide angle lens built into the camera has positive distortion, the camera lens system combines with the rifle scope by correcting with negative distortion.

From our testing, we have seen that the system performs well and leads to the field of view of the camera decreasing from 170 degrees to 110 degrees. A 110 degree field of view is not ideal, but we have found through testing that this is the limit of our system when using this particular camera. We have provided images of the results of our tests in the Hardware Testing section.



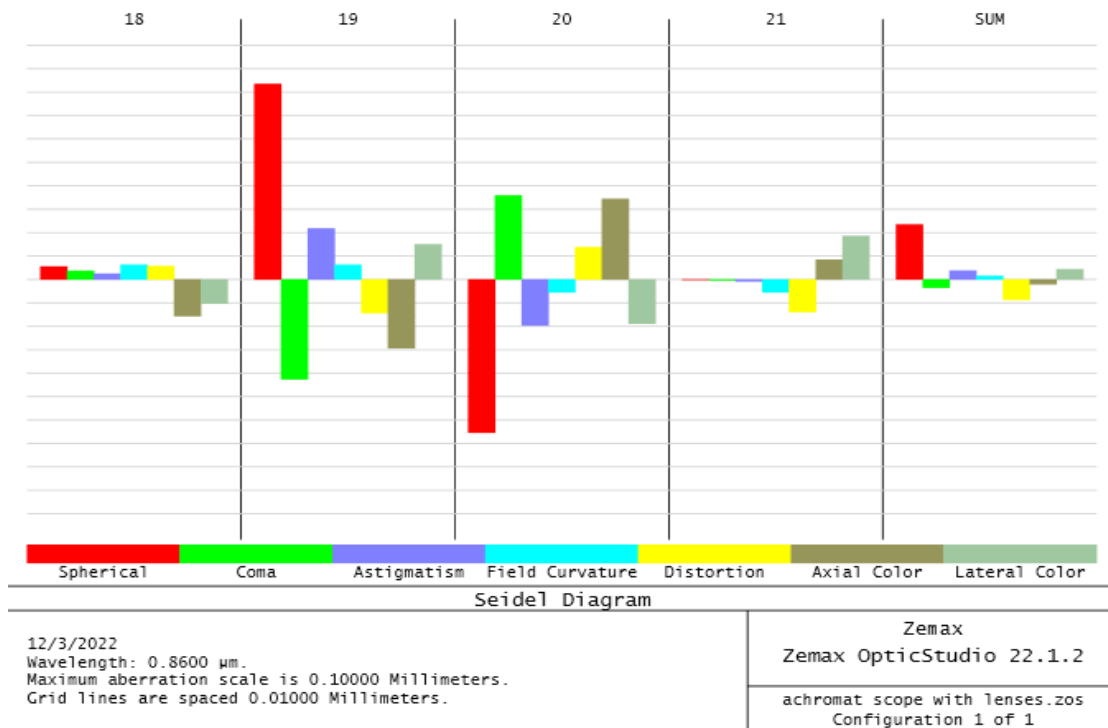

Figure 17. Camera Lens System Aberrations

### 5.1.6 Variable Focus IR Flashlight

Given the extremely small viewing angle of the 860 nm LEDs, the design for the IR flashlight has a lot of freedom for design. The main goal of the flashlight is to be able to control the focus of the light such that it is a desired size and angle. We will discuss the various design parameters surrounding the flashlight. Since it is a flashlight, the most obvious design parameter is the light transmission. We need light transmission as maximized as possible for 860 nm light, meaning we will need to minimize the number of lenses in the systems while selecting lenses with near IR antireflection coatings to maximize transmission.

Another parameter is the position of the LEDs. Depending on the type of lens system used, the position of the LEDs will significantly alter the size and angle of the output light. However, we decided to fix the position of the LEDs at a 30mm distance away from the first lens. This is a decision we made when considering the construction of the housing for the flashlight rather than an optics design decision, so the optics design will be designed under this constraint. If we find that this is too large when constructing the prototype, we can make adjustments for the design accordingly.

Finally, the main parameters we focused on in our design were the focusing sensitivity and compactness of the flashlight. We define the focusing sensitivity as the change in

divergence angle of the output beam in relation to the amount of distance a lens moves to adjust the focus. For a system with large focusing sensitivity, the divergence of the output beam will rapidly change with slight adjustments to the lens. Greater focusing sensitivity leads to more compact lenses at the cost of less precision when adjusting the lens.

For our design, we will use a concave lens to expand the LED light and then focus that light using a convex lens for an efficient and compact design. In this system, we will need to keep the concave lens at a fixed position and move the convex lens to change the focus. The focusing sensitivity of the system increases with the power of each lens, so we needed to pick a combination of lenses that would balance between compactness and precise selection of beam spread when moving the convex lens. In terms of numbers, we wanted the convex lens to move at most 20mm for a 5 degree change in full divergence angle. The total axial length of the system would also be less than 75mm. These specifications were based on telescoping flashlights sold on the market.

For the lens selection, we chose the Edmund Optics #45-924 25.4mm plano convex lens with VIS-NIR coating (0.4% reflectivity at 860 nm) and the Newport KPX184AR.16 50.8mm plano convex lens which has 0.3% reflectivity at 860 nm. Other flashlights on the market typically use smaller lenses that are unorthodox sizes such as 32mm lenses. We feel that our design may be a little too bulky in size due to the 50.8mm convex lens, but this is something that cannot be changed as sizes in between 25.4mm and 50.8mm are not commonly available.

We simulated the lens system in Zemax and evaluated it at a 860 nm wavelength. We set the angle of the rays emitted from the object to be 10 degrees. This is to simulate the viewing angle of the LEDs. The positions of the fields were spatially 0mm and 5mm relative to the center of the lens system. This is because the diameter of the LEDs are 5mm each, and we planned on using multiple LEDs when we actually constructed the flashlight. **Table 8** and **Figure 18** show the lens data and layout of the flashlight when the convex lens is positioned so that the output light has a 0 degree divergence angle.

	Surface Type	Comment	Radius	Thickness	Material	Coating	Clear Semi-Dia	Chip Zone	Mech Semi-l
0	OBJECT Standard ▾		Infinity	30.000			0.000	0.000	0.000
1	(aper) Standard ▾	#45-924	-51.680	3.500	N-BK7	EO_VISNIR_5...	12.000 U	0.500	12.500
2	(aper) Standard ▾		Infinity	52.500		EO_VISNIR_5...	12.000 U	0.500	12.500
3	STOP (aper) Standard ▾		Infinity	10.722	BK7		25.400 U	0.000	25.400
4	(aper) Standard ▾	KPX184	-45.633	1.500E+04			25.400 U	0.000	25.400
5	IMAGE Standard ▾		Infinity	-			25.215	0.000	25.215

**Table 8. IR Flashlight Lens Data**

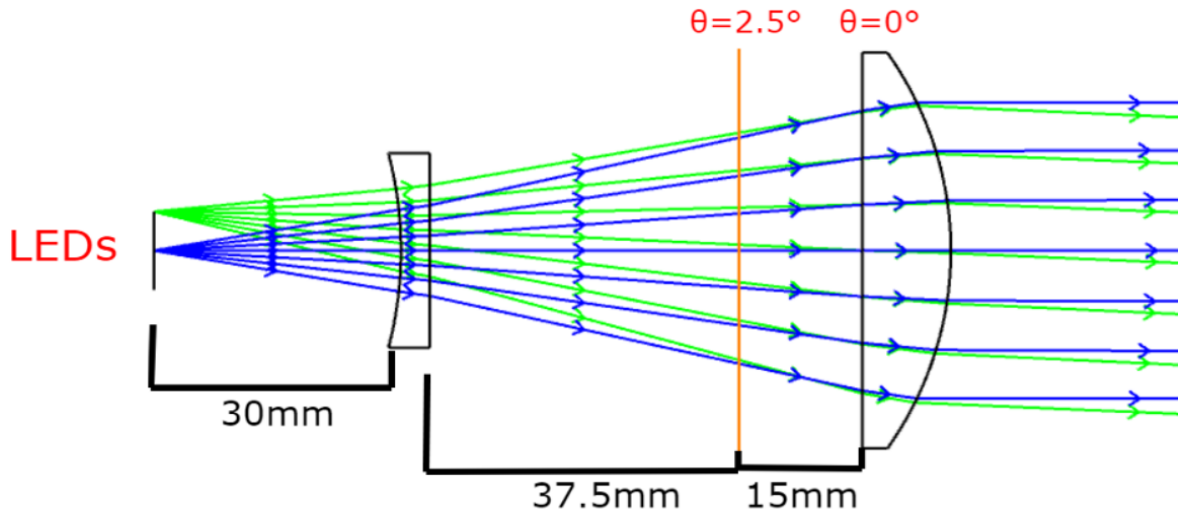

**Figure 18. IR Flashlight Lens Layout**

In this design, the convex lens moves a total of 15mm away from the concave lens to change from a 5-degree full divergence angle to outputting a collimated beam. Not including the distance from the LEDs, the total axial length of the lens system is maximum at 66.7mm. This makes for a compact lens system that can allow for precise adjustments and has a size comparable to that of telescoping flashlights sold on the market.

### ***5.1.7 Stretch Designs: Safety Camera and Other Rifle Optics***

In this section, we discuss the optical design elements that we consider as stretch goals. The main two stretch goals for the optical design include the human detection camera and a lower magnification optical sight such as a reflex sight.

#### **Human Detection Camera**

First, there is the human detection camera. Since there is a chance that we may not implement this system into the final design, we will briefly describe what kind of design will be necessary for this camera. Generally, in terms of optical design, the design would be very similar to that of the night vision CMOS camera, especially if a camera with lenses preinstalled was used rather than a raw CMOS sensor. We will discuss the case of a raw CMOS sensor since the overall design approach would be essentially the same as the night vision CMOS section.

For our camera, we would want a small field of view at around 20 degrees to increase depth of field for a clearer image at a variety of distances away, which is important since the algorithm would need to recognize a person's facial features whether they are standing close or far away. The main parameters affecting field of view are the sensor size and the focal length of the lens being used.

With larger focal lengths, the field of view decreases and vice versa. On the other hand, as the sensor size increases, the FOV also increases. This relationship is shown in **Figure 19**. If we assume that we would use a 1/3 inch CMOS sensor, then for a 20 degree vertical FOV, a lens of focal length 4.945 mm would have to be used. More complex lens systems can be made such that combinations of lenses produce the same FOV while correcting system aberrations, but this will not be delved into further.

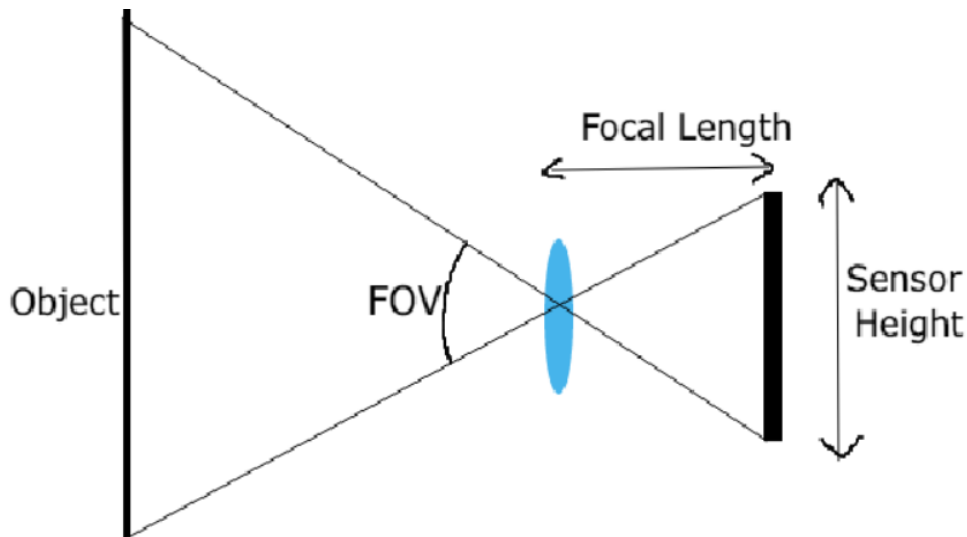
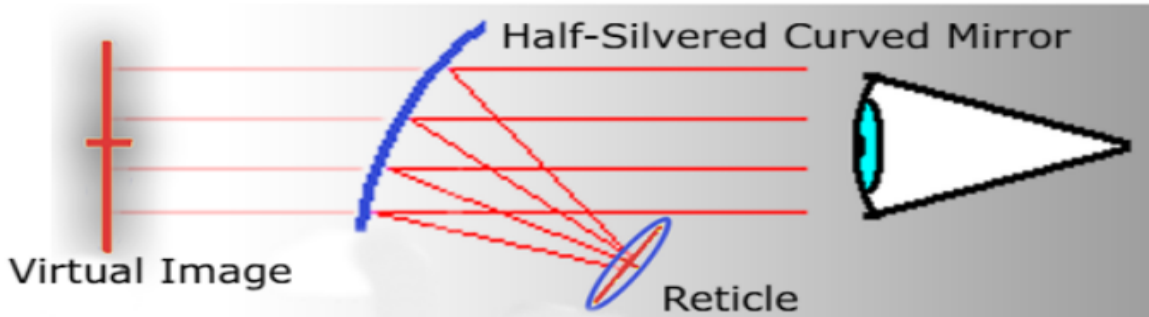

**Figure 19. Sensor Field of View Concept**

### **Reflex Sight**

The other main stretch goal is to include a low power optic sight for the laser rifle. Compared to holographic sights, which require the use of holographic gratings and laser diodes, reflex sights are quite simple to make, although the materials needed to make them are hard to acquire and expensive. There are a variety of ways to make reflex sights, but the most common design uses a half-silvered curved mirror and a point source such as an LED illuminating some form of reticle. In the case of red dot sights, the LED or an aperture in front of the LED is the reticle.

We consider this a stretch goal because finding a half-silvered concave mirror that is of a suitable focal length and size is difficult and expensive, but we have managed to purchase one for use in our project. In **Figure 20** (41), a ray diagram of a reflex sight is shown. The LED is placed at the focal length of the curved mirror so that the light reflecting back to the user is collimated. The user's eye focuses the collimated light of the reticle, allowing the reticle to be seen when looking through the mirror.

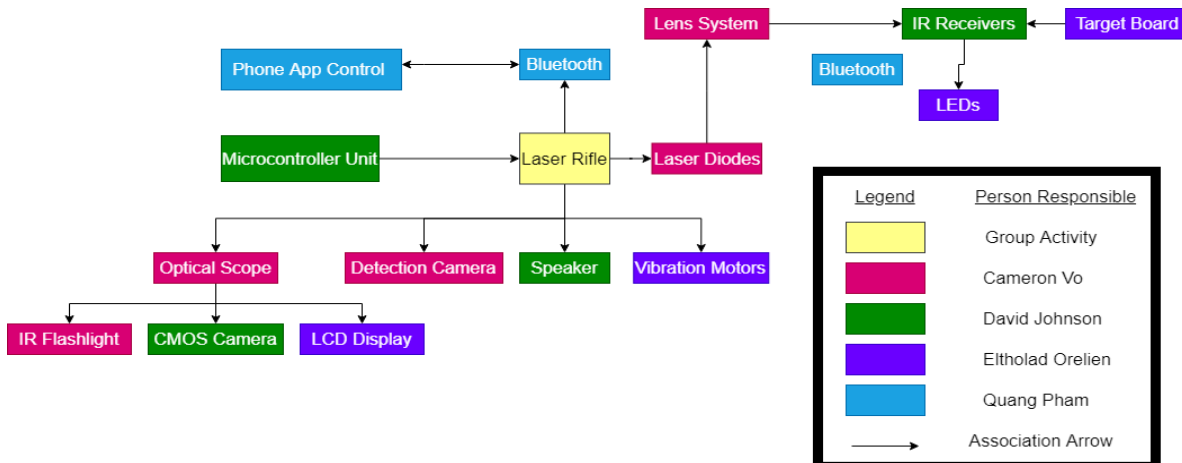

**Figure 20. Reflex Sight Diagram**

The half-silvered concave mirror we will use has a 100 mm focal length with a 62.5 mm diameter. The mirror works like a 90:10 beam splitter with 10% of the light being reflected. This optical sight is used for viewing at 1x with the reticle and does not magnify the image in any way. As a result, there is no worry about parallax errors, but a poor alignment of the mirror with respect to the reticle can result in astigmatism and other aberrations when viewing the virtual image. As stated previously, the design for this reflex sight is quite simple and is essentially a collimation task. Most of the design will be through the construction of the sight itself. The Solidworks 3D model used in the design will be shown and discussed further in the Prototype Construction section.

## 5.2 Hardware: Electrical Designs

In this section, the various electrical schematics designs will be provided. In **Figure 21**, a block diagram maps out the interactions between the various hardware (including optical) components that was used in our project design and who is responsible for each component.

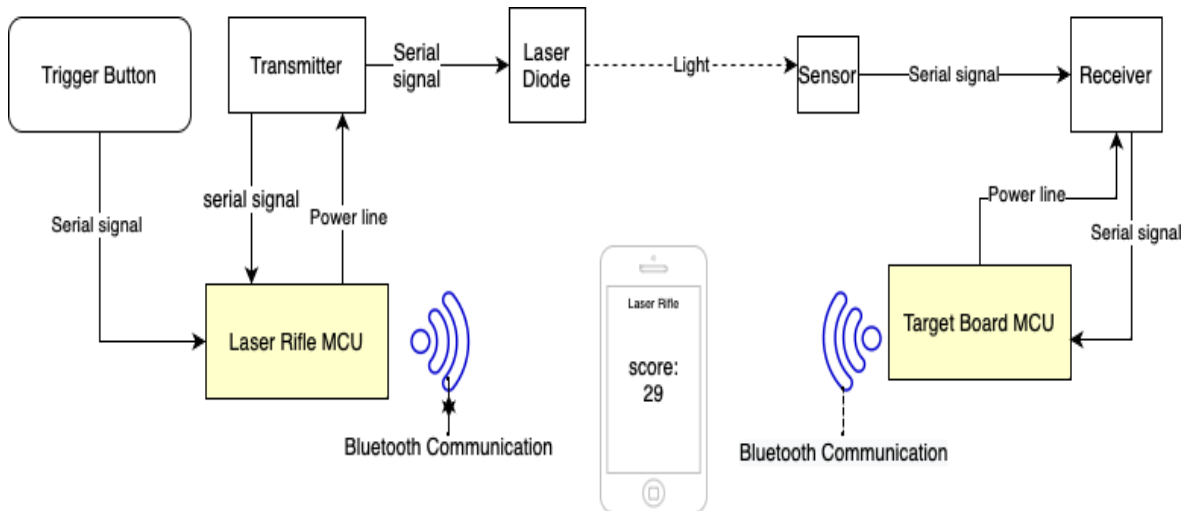

**Figure 21. Hardware Block Diagram**

For a better understanding of what our system actually looks like in action, we have come up with the **Figure 22** below. This is a block diagram that demonstrates our fundamental hardware system and how each component interacts with one another on a more intuitive level. This is simpler than the final design approach complete with all system components, but this shows the primary concept that will help our team design as well as guide our design iterations later on.

When the “Trigger” button is being pressed, it sends a signal to the Laser Rifle microcontroller unit that will send the instruction to the Transmitter. The Transmitter will then send a serial signal to the IR Laser diode that will cause the diode to emit modulated light defined by the signal. The Sensor will capture the light from the diode and send that data to the Receiver (the Sensor and Receiver are both integrated into the IR receiver). The Receiver will accept the data and send the acknowledgement data being represented as a Serial Signal to the Target Board microcontroller unit.

Our software is represented as the mobile app communicating with both microcontroller units through Bluetooth. The wireless communication is done through the onboard antenna of each microcontroller.



**Figure 22. Prototype Operations Block Diagram**

### 5.2.1 Audio System

In order to have sufficient audio output that would signify pulling the trigger to the laser rifle it was necessary to not just have a speaker but also a system that could be controlled by the MCU and output a firing noise. We ended up choosing the MAX98357A as the in between for our speakers and ESP32. In order to test the audio amplifier we purchased the MAX98357A Audio Breakout board from Sparkfun. Although it was our intent to

significantly test this audio system before committing to including it in our design, there have been unfortunate delays in shipping.

One significant reasoning towards choosing this component from Sparkfun is that not only do they provide a more than adequate method of testing the chip but also we figure that we save space on our board by only integrating the necessary portion of the test board for our overall PCB design. Doing so would allow us to save space on our PCB thus lowering our overall footprint. When looking to create the schematic design through our selected choice of PCB designer, Altium, the construction required no effort due to Sparkfun providing an easy to download and utilize schematic file for Eagle.

One feature that will be struck from our design is the option to select an audio channel. This system allows you to select between the left and right audio channel, allowing you to drive two separate speakers if needed. This speaker selection option is made possible through 2 jumpers on the board. Since we decided to use a single speaker to output for the laser rifle, neither jumpers would be necessary. The speaker selection feature is made as a separate piece of the schematic. Also, the Sparkfun schematic includes a pin header placement design that was removed since the connections from our circuit will be contained within our PCB.

**Figure 23** displays what our ideal audio amplifier circuit and connector that goes to the speaker will resemble. The MAX98357A IC chip listed below is the audio amplifier that was mentioned from the Parts selection section. The chip includes 9 pins VDD, DIN, BCLK, LRCLK, SD\_MODE, GAIN, GND AND the output pins. Its input voltage pin is VDD which will be connected to a 3V3 supply bus. As per the data sheet this should sufficiently power the chip.

There is a ground pin which will be connected to the 3V3 bus ground as well. The GAIN pin is used to set the gain in decibels of the amplifier depending on its configuration. According to the datasheet, when the pin is not connected to anything the default gain is +9dB which should be more than enough output for the user.

The SD-MODE pin is meant to be the shutdown and channel select pin for the amplifier. The datasheet states that the pin can be pulled high to select the left channel, pull-up through the use of a small resistor to select the right channel, pulled low to place the device in shutdown, and or pull-up using a very large resistor to combine both channels into a single channel and drive a single speaker. Our design only includes the use of one speaker so the optimal choice was to include a large resistor and combine both channels.

In **Figure 23** a 1M $\Omega$  resistor is connected to the 3V3 bus to control this pin. The DIN is the digital input pin, and the LRCLK and BCLK pins are both clock inputs. These 3 pins will be connected to the ESP32 so they are left unconnected. The OUT plus and minus pins are connected to a 2 pin terminal block which will then connect to the speaker. As stated in the hardware test plan, once the MAX98357A breakout board is delivered this system will be tested on a breadboard to check if it is all viable.



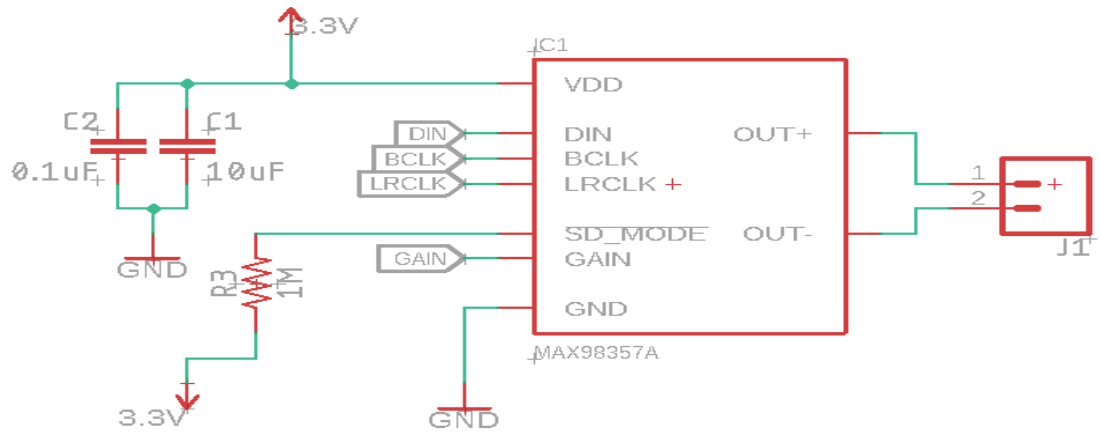

**Figure 23. Audio Amplifier and Speaker Connector**

### ***Update***

We used the hot plate and the reflow solder machine when attempting to implement the MAX98357A audio chip on our PCB design. We used approximately 5 audio chips along with the PCB silk screen and all of them bridged no matter which soldering method we used. Since the audio chip bridged, we omitted the audio portion of our design.

## ***5.2.2 Laser Driver Circuit***

The laser diode is one of the most significant components of our design so when researching designs that would allow us to drive the laser diode quickly and effectively we looked into several avenues. One in which led us down the path in designing a system that implemented a summing amplifier.

Another option that was presented to us was using a BJT to drive our laser diode to simulate a trigger pull and the firing of a laser during gameplay. The overall concept of this design is that first it will be necessary for the user to activate the switch (seen in figure which will act as a safety switch for the rifle. Most firearms come with an effective “safety” switch which restricts the weapon from being fired despite being loaded. the user activates the trigger button with a simple press or pull.

The button will be connected to the microcontroller as either an active-low or active-high, either or should be fine. Once the microcontroller recognizes the trigger activation it supplies 3.3V to the gate of BJT for as long as the button is pressed. Through software it will be possible to change the pulse duration since we are looking to have varying

firing modes. The voltage applied to the gate should then allow the laser to turn on for the duration of the pulse.

In **Figure 24**, we provide the actual schematic we used for the design of this laser diode and driver. In the figure, we are essentially utilizing 3 main components and the 3.3V voltage rail to implement this design. Starting from the top of the design we have the 3.3V supply which will be provided by the 3.3V voltage regulator.

The PWM represents a 3.3V Pulse Width Modulated signal input which can be supplied by the ESP32 microcontroller. This voltage will be pushed to the gate end of the BJT when the user activates the trigger. In turn causing the laser diode to fire..

We found that a 1k ohm resistor was perfect as a gate to source current limiting in order to apply the 38khz PWM signal to our laser. We also utilized a potentiometer from source to collector in order to make small adjustments to the amount of current flowing through the laser. Lastly since our laser is surface mount it is important to note that the laser needed its own PCB. Therefore JP2 is a pin header which is wired to the pin headers on the laser rifle PCB.

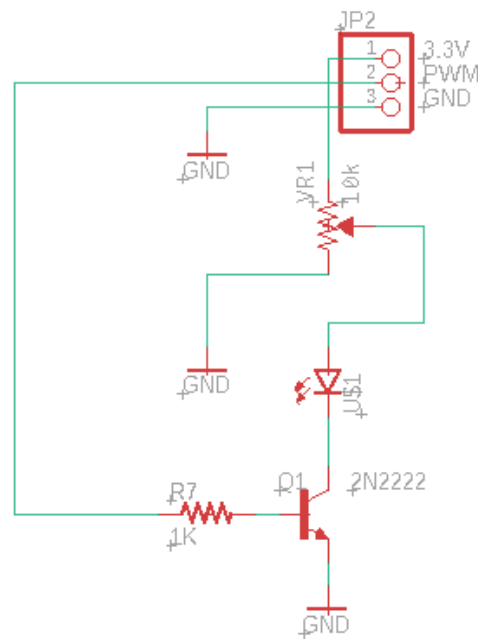

**Figure 24. Laser Driver w/ BJT**

### 5.2.3 Vibration Motor Circuit

The vibration motor only requires a positive and negative connection to operate that will provide an input voltage of 5 V and a current of at most 250mA. Therefore the circuit should be a simple one in which the vibration motor is controlled by the user's trigger pull. Therefore, **Figure 26** is an example of the simple design that we were looking for. In order to have a simple trigger pull system we used the FEEDBACK signal shown below to trigger the vibrational motor through the use of a transistor. The motor was also plugged into a 2 pin terminal which allowed easy replacement of the motor.

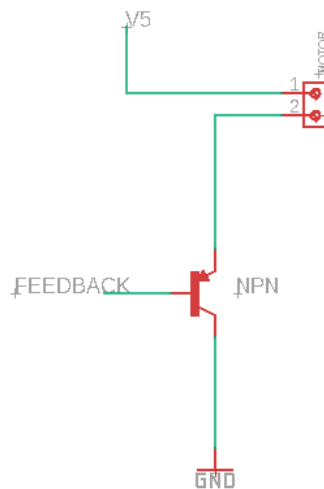

**Figure 26. Vibrational Motor**

#### **Update**

We tested the Parallax Vibration Motor 28821, Parallax Vibration Motor 28822, and the Vibration ERM Motor 2550 RPM 5V from Vybronic Inc. When testing the vibration motors, we noticed the voltage regulators on our PCB began to overheat. Therefore to prevent any failures in our system, we decided to omit this portion of our design from the final demo. The vibrational system works well but possibly including a heat sink for the 5V regulator powering this device would prevent any overheating issues.

### 5.2.4 Target Board IR Receiver Circuit

The IR receiver is really just a receiver module for infrared remote control systems. It is made to receive long burst codes which are essentially just the IR signals that we will be sending using the IR diode. Since the purpose of the sensor is to read the IR signal once the rifle trigger is pulled and the laser diode emits it should always be in a powered on state once the Target board is powered on.

The IR receiver module chosen, the TSOP986, is a 3 pin through hole component as shown in the schematic in **Figure 27**, so for the footprint we used a 3 pin header. We were unable to find a footprint that corresponded to this component so we used this header.

It is important to keep the design of this footprint simple because the enclosure for the target system needed to work well with the physical dimensions of the PCB. However, we decided that there would be multiple sensors on the board corresponding to the different target areas on the board. **Figure 1** in the Objectives section goes into more detail behind the concept. The receivers themselves only require small amounts of current (0.45mA) and consume a small amount of power (10mW) at a maximum. The overall idea is that the IR receiver module is excited by a 38kHz signal from the IR diode. Once the IR sensor detects this beam it outputs a signal to the MCU which then completes any task such as lighting the LED indicators around the affected sensor.

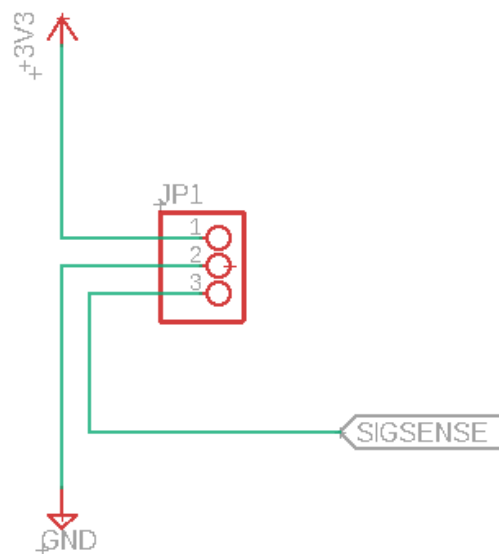
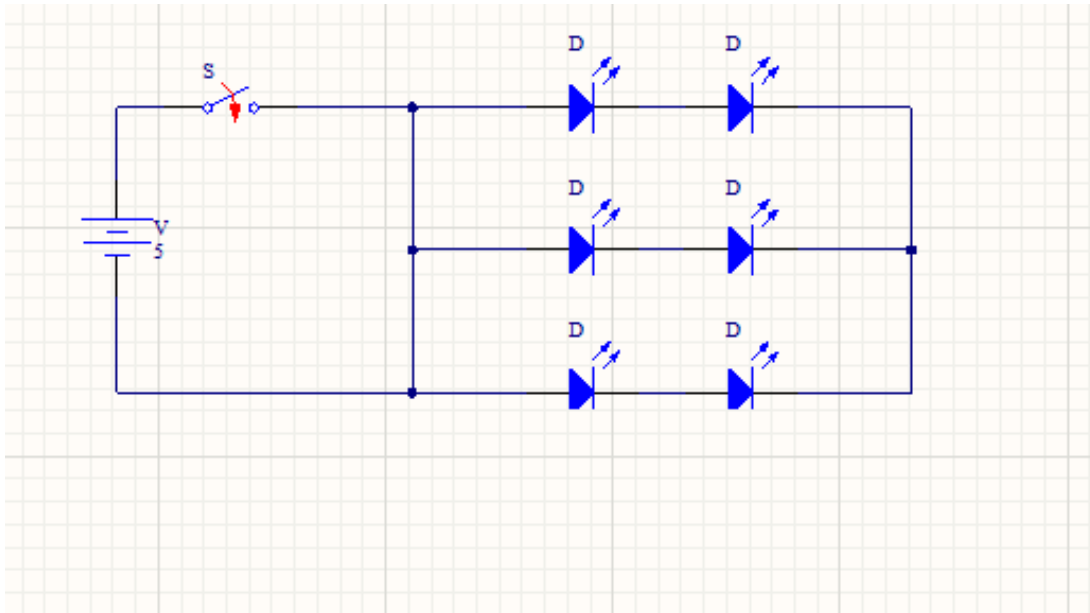

**Figure 27. IR Receiver Schematics**

### **5.2.5 IR Flashlight Circuit**

In our project we are using an LCD display as an alternative option for viewing the target. The IR flashlight will be used to complement the LCD display we are using to essentially act as a night vision system. We are using the LCD display along with the IR flashlight to further the realism of our laser gun. The addition of the IR flashlight will allow the user to see their target better in dark and or poor lighting conditions. Using IR LEDs allows for

good sensitivity without being easily affected by any ambient light. IR LEDs are a great option that allow for low power consumption and are relatively inexpensive (44). The preliminary IR flashlight circuit is shown in **Figure 28** below.



**Figure 28. IR Flashlight Circuit**

### **5.2.6 Power Design**

The devices that will be receiving power are the laser rifle and the laser target. This section's purpose is to identify the flow of the power systems for each device and the possible monitoring method to assure proper operation. Both the Laser rifle and laser target will be receiving power from internal 9.6V rechargeable batteries in order to keep the design simple. Both will also provide current to the microcontrollers and peripheral devices attached to them.

The sources will need to be regulated and adjusted to better fit the PCB and meet requirements. The 9.6V supply is selected not only for high potential and peripheral power delivery but also the recharging capabilities will allow for longevity and cost savings. However the 9.6V will need to be regulated down.

It is ideal to provide a longer lasting device system therefore we looked towards overshooting some of the power capabilities as much as possible. The general scope of overall efficiency will be lowered but this will be helpful for peripherals and stretch goals. It is necessary to understand which components of the system require which voltages in

order to operate correctly. An overview of the power system design can be found in **Figure 29**.

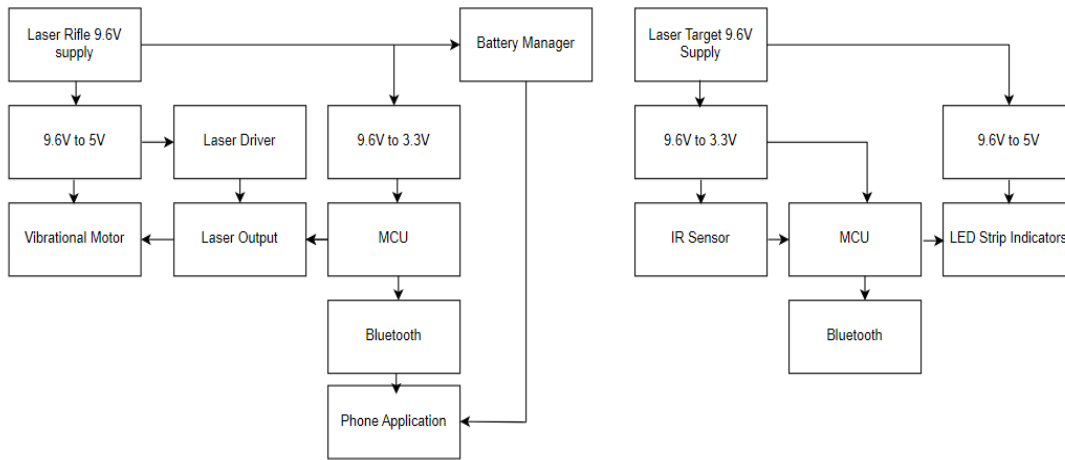

**Figure 29. Power System Design Rifle and Battery**

In order to reduce the 9.6V battery supply to stable DC voltages of 3.3V and 5V, it was necessary to use a voltage buck regulator. That is why we choose two 78M series regulators to do such a task. It is our opinion that using 2 of these fixed regulators would make the PCB design fairly simple. According to the data sheets of both of these Texas Instrument components in order to get clean outputs you simply need to use input and output capacitors. Schematics for the 3.3V and 5V regulator are shown in **Figure 30** and **Figure 31** respectively.

Throughout the process we tested not just different regulators but also different types. At one point we attempted to use switching regulators to reduce power loss but found those quite difficult to mount to a PCB. So we eventually went with dual LDO voltage rails. The 5V regulator provides upwards to 1.5A of current while the 3.3V provides 500mA.

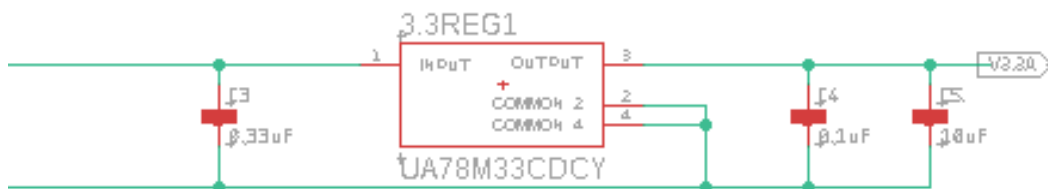

**Figure 30. 3.3V regulator**

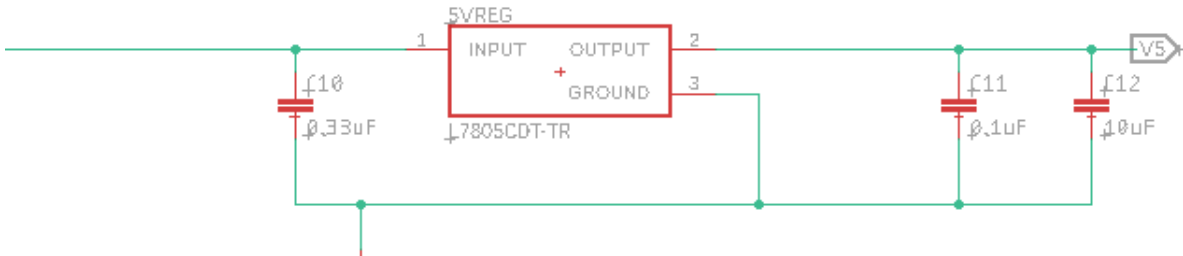

**Figure 31. 5V regulator**

Not portrayed in these figures is that we also used a reverse bias diode and a fuse both connected in series with the battery to provide extra layers of protection. The data sheets of these devices say that such additions are not necessary but it is always better to be safe than sorry when implementing power designs.

### **5.2.7 Battery Life Indication**

In this section, we will discuss the battery monitoring system we intended to use to monitor the batteries charging and discharging to give us the battery voltage and battery percentage. Monitoring the voltage level of our battery would allow us to foresee any failures or damage within our system due to improper charging and or discharging. This system will act as a safety measure to ensure our system and our battery is responding properly under the right conditions. Our goal is for the battery status to be sent directly to the user through bluetooth and display this battery status on our mobile phone application.

To test this we will need our ESP32-WROOM-32-N4 development board, our battery module, and various components such as resistors. The battery we intended on using has an input voltage of 9.6V which will need to be reduced to a stable DC voltage. The development board we are using supports an input analog voltage of 3.3V, therefore we would have needed resistors to lower the input voltage of our battery.

Once the battery is connected to the development board and respective resistors, we will be able to input the source code and monitor the battery data. As mentioned this battery data includes the battery voltage and the battery percentage. This system is not perfect due to the tolerance of resistors being approximately 5%. The resistor tolerance will affect the output voltage being read, to fix this we can use a multimeter to compare the difference in voltage to the readings within the mobile application (45).

Although it was definitely our intention to create this system we ultimately moved it towards a stretch goal list and were unable to follow through in its implementation. It



was also fairly unnecessary because we found after testing that our system takes quite a while to drain the battery and thus would not see noticeable differences in the battery life percentages.

### **5.2.8 PCB Manufacturer and Design**

In this section we will discuss the design and assembly of our PCB as well as choosing an appropriate manufacturer to meet our requirements. We will discuss the components and the manufacturer we intended to send our design to upon completion.

Before sending our PCB design off for printing we will have to consider many factors including, the manufacturer, the overall price, size of the PCB, location, manufacturer reputation, and time to ship. When an engineer designs a PCB, one of the most important factors is usually price, to increase the company's profit margin as well as having the budget to use elsewhere. For us price will not be the main consideration in choosing a PCB manufacturer.

Since our project is constrained by time, we will need to choose a company that can deliver our PCB fast and efficiently while also being known to deliver quality products. Since we want to receive our PCB as quickly as possible, we will have to look at the location of each manufacturer under consideration. It is important to consider that most PCB manufacturers are located in China or somewhere overseas, therefore it is essential that we account for this in the shipment time.

Ideally we will select a PCB manufacturer that is located in the United States, however this limits our options of PCB manufacturers to choose from. Aside from time to ship, we will also need to consider the manufacturer's reputation. Looking at the manufacturer's reputation will include the build quality as well as customer support if something is not right upon receiving our PCB.

We had to estimate the dimensions for our PCB to get an idea of the price. We already have the chassis for the laser gun, therefore we have a good idea of what the dimensions of our PCB should be, or at least the maximum dimensions our design will allow.

**Table 9** compares the different PCB manufacturers using the dimensions 76mm x 38mm x 1.6mm (~3in x 1.5in x 0.063 in) in length x width x thickness. These PCB dimensions are just an estimate based on measurements from the inside of our laser gun where we planned to place the PCBs. The table below compares the manufactures with their respective PCB cost for five PCB's, the shipping cost, build time, and estimated receival time using the PCB instant quote function.

Manufacturer	Location	~ PCB Cost (5x)	Shipping Cost	Build Time	Shipping Time
PCBgogo	China	\$5.00	\$28.00	24 Hours	3-5 Days
PCBWay	China	\$5.00	\$23.69	24 Hours	2-4 Days
JLCPCB	China	\$2.00	\$19.05	1-2 Days	2-4 Days
AllPCB	China	\$11.00	\$25.00	24 Hours	2-5 Days

**Table 9. PCB Manufacturer Comparison**

The table above compares the different PCB manufacturer companies we look at as potential candidates for our design. The manufacturers we compared are all based in China. We were able to find a PCB manufacturer in the United States and Canada, however, their quoting system made it difficult to get a set price, their prices are most often much higher, and they were not as highly reviewed as the manufacturers shown in the table above. Based on the build time and shipping time for the manufacturers we found in the table, we shouldn't have any issues getting our PCB in a timely manner.

## 5.3 Software

In this section, we introduce a companion mobile app to operate the laser rifle and the laser target. The section will dive into low-level details, about this app, and design decisions in addition with multiple interfaces of the software. We will also describe the constraints that come along the way that become our limiting factor so that the programming can be more approachable and easily develop.

### 5.3.1 Software Overview

The app will pair with the Laser Rifle and the Target device using the Bluetooth technology. It can configure the recoil actuator of the rifle, track the ammo count of the rifle, configure and modify the firing mode in any way a user desires. Users can start a game on the app and the scoring can be viewed by connecting the app to our Target device. Below in **Figure 32** are the block diagram for the phone app design and its functionalities.

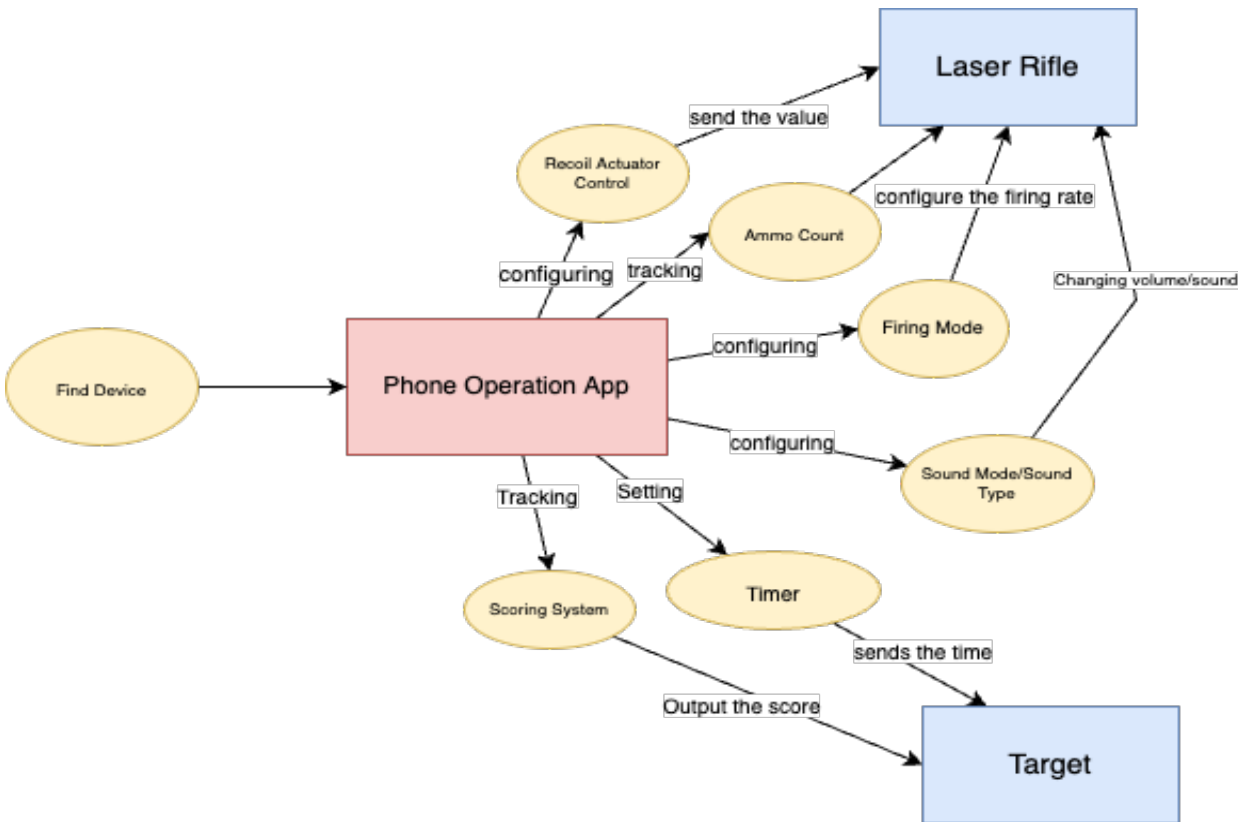

Figure 32. Mobile Phone Application Block Diagram

### 5.3.2 Software Design Tools

In order to complete the software development there are a few tools necessary. The main tools that are needed are the editor which can compile any language necessary, software libraries needed, and application for interface design tools.

#### React Native

We need a tool to develop one code base that will then transpile to be native apps in iOS and Android. Thus, we chose to use React Native to deploy to iOS and Android. Using React Native we can program using a special Javascript language along with the help of React libraries to build our app. A brief description of React Native, it is an open-source mobile application framework created by Facebook. React Native knows how to talk to native platforms on Android and iOS and how to render native widgets. It gives us a bunch of these widgets as React components so that we can build a user interface with these components. React Native also gives us access to some native platform APIs.

For example, we can access the Bluetooth system of the mobile device and pair it with our current project device. The tool also gives us more tools to connect Javascript to Native Code. How React Native works, we use special components in JSX format like `<View>` and `<Text>`. These components are compiled in react Native and converted to native elements in native apps. For example for Android, the `<android.view>` to structure the content. On iOS, that would be `<UIView>`. Then in React Native, we use `<View>` tag to compile into native widgets on Android and iOS.

The reason why we choose React Native because the tool lets us have the freedom to build apps for all platforms and we also can export from Expo CLI to the React Native CLI so that we can take control over the management of the project locally. I can create and run my applications from there.

### **Figma**

For prototyping our current app without needing to code up, we use Figma as our user interface design. Figma is a collaborative web application for front end design. The feature set of Figma focuses on User Interface and User Experience design. The tool helps represent the concept of our mobile app design for everyone in the team. Figma allows us to make the tool our own. The ease of access allows us to have all we're needed to work as efficiently as possible.

We also chose Figma because it lets us work on more iterations in a shorter time without the hassle. Version Control is also a very important feature in Figma. Since we have people work on the same file at the same time, it's so important to have the built in 'Version History' to go back to when something we did was wrong or looks bad and then everyone can continue work on the next prototype without worry about messing up the main prototype.

### **Integrated Development Environment (IDE)**

We decided to use Visual Studio Code as the primary code editor for mobile app development. VS Code includes enriched built-in support for development applications that make extensive use of the ability to run Javascript both on a client as well as the server, and this is called Node.Js.

VS Code has great tooling for app technologies such as JSX/React Native because it has a public extensibility model that lets software engineers or developers build and use extensions that richly customize their edit-build-debug experience. Visual Studio Code also includes an interactive debugger that allows us to dive into our code and go through the code step-by-step. We dive this deeper in the Test plan section.

Arduino Integrated Development Environment is utilized to connect to the Arduino hardware to upload programs and communicate with them. Programs written in the software are called sketches. These sketches are written in the text editor. In the editor, we need to write in it with C++ language. Most libraries that provide extra functionality for use in sketches are C++ classes. The software also has the console that displays text output including complete error messages and other information. Another cool thing about

Arduino Software is that there is a Serial Monitor that displays serial sent from the Arduino board over USB. It's an essential tool because it is used as a debugging tool, testing out concepts or to communicate directly with the Arduino board.

## **Flutter**

Flutter is an open source UI software development kit created by Google. Flutter transforms the app development process into mobile, web, desktop and embedded apps. Similar to React Native, the tool lets us have the freedom to build apps for all platforms and we also can export from a single codebase using the language Dart, Java, C/C++, and more that we can take control over the management of the project locally. Like React Native, Flutter compiles all the way to native code (46).

We have the option to use Dart instead of Javascript, it's an easier language to learn and offers the following features where it supports interfaces and abstract classes. We thought this would be helpful in a way that we can implement settings features to configure our Bluetooth devices much more easily. And finally we thought using this would help reduce the development time and costs of our project, while also making us focus on the hardware design better.

### ***5.3.3 Use Case of the System***

We create a use case diagram to identify, clarify and organize system requirements. In the **Figure 33** below, we require the user to turn the device power on and the system needs to have battery, microcontroller units, and laser diodes before the user can press the trigger button of the Laser Rifle. The user can configure devices for the Laser Rifle and the Target if they wanted to. In order to configure devices, the user needs to make sure that the Bluetooth is available and Bluetooth turns on in the device. Also, the user can pair two devices on the mobile app through the Bluetooth communication.

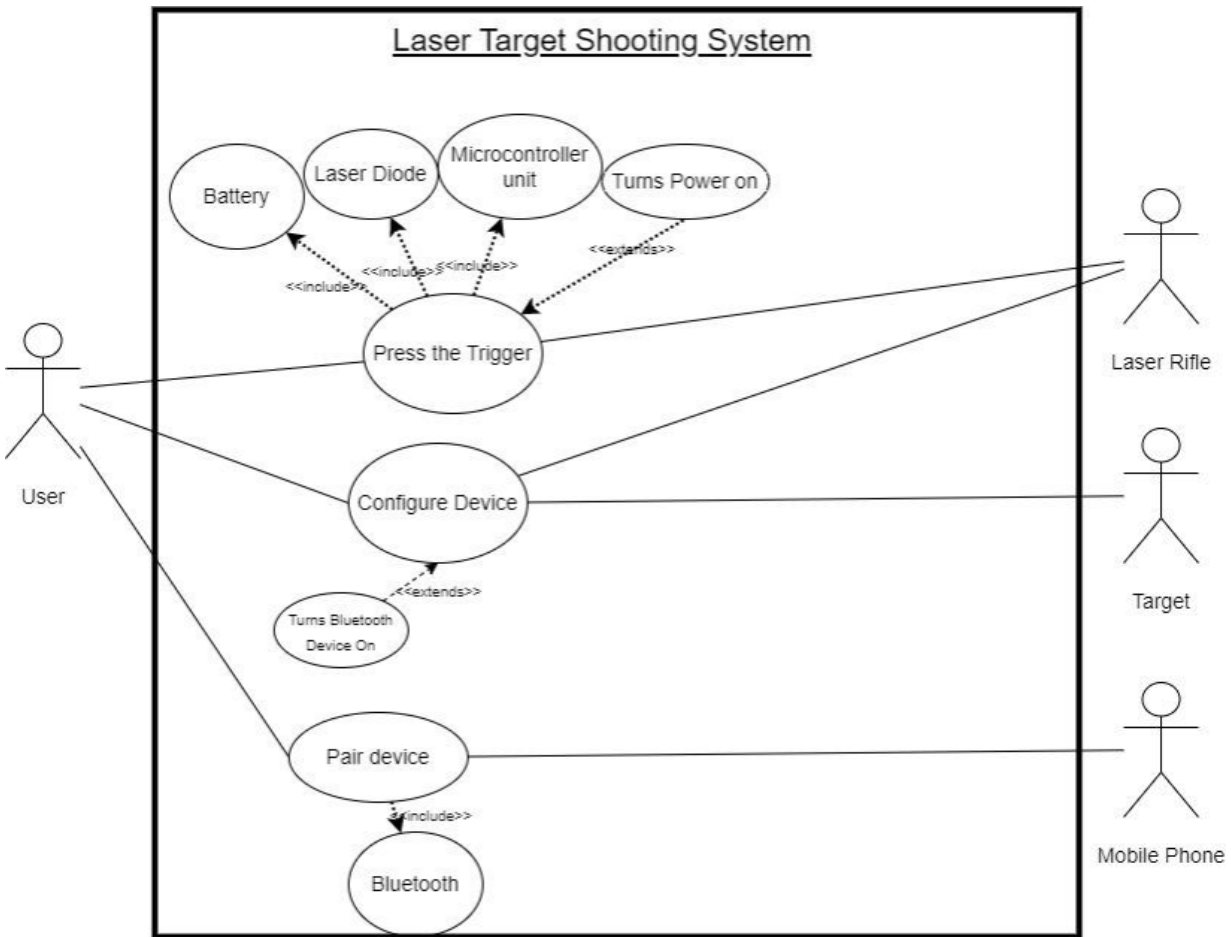

Figure 33. Laser Target Shooting System Use Case

### 5.3.4 PCB Design Software

#### Autodesk EAGLE

Autodesk Eagle was the first PCB design program that came to mind since the majority of our group has experience with it from our Junior Design course. We all have access to the educational license for Autodesk Eagle since we are students at UCF. Unfortunately, when we took Junior Design we were unable to actually send our designs to be printed due to the global part shortage issue with many electronics companies. For all of us, Eagle is our only experience with PCB design software so this made Eagle our first choice for PCB design software.

Autodesk Eagle has many features including the schematic editor, PCB layout editor, PCB library content, as well as an online PCB community. The Eagle schematic editor includes the SPICE simulator, modular design blocks, and electronic rule checking. The SPICE simulator allows you to test and validate circuit design and performance. The

modular design blocks have reusable design blocks that you can drag and drop between multiple projects, the modular design blocks also have schematic and PCB circuitry. The electronic rule checking is a way to validate your schematic designs and stay on track and make sure you have a functioning schematic design.

Another feature Autodesk Eagle has is the PCB layout editor which includes real-time design synchronization, intuitive alignment tools, push and shove routing, obstacle avoidance routing, new routing engine, and design rule checking. The Eagle real-time design synchronization keeps your changes between the schematic and layout in sync. The intuitive alignment tools arrange and order the PCB design objects.

The push and shove routing is an adaptive tool meant to push and shove you PCB traces to ensure they abide by the design rules. Obstacle avoidance routing aids in ensuring traces get to the appropriate destination by maneuvering around the PCB design. New routing engine allows for quick PCB design. Tools within the new routing engine include loop removal and cornering. The design rule checking allows the user to control the flow of their design and abide by the PCB rules of design to avoid unwanted outcomes.

Furthermore, Autodesk Eagle includes PCB library content. Online libraries are useful for finding many different parts to place in your PCB circuit with a continuously growing library. The PCB library content also allows for 3D PCB models to help the user get an idea of what their PCB will look like when it is sent off for printing, and to make sure the PCB fits in the hardware you would like to implement it in. Complete components allows the user to search physical hardware components such as MCU, chips, op-amps, symbols, and footprints (47).

### **Altium Circuit Maker**

Altium Circuit Maker is another PCB design software tool that we don't have much experience with, however we found it easy to pick up with prior experience with Autodesk Eagle and ultimately decided to use it for our project. Altium is a very useful PCB design software to use when working with a group of people to design a PCB. Using Altium allows us to share circuit designs and work on them simultaneously as a group. Altium shares similar features to Autodesk Eagle while also being a free program to use for students. Altium has a component library that in my opinion is easier to navigate compared to that of Autodesk Eagle.

Altium Circuit Maker has thousands of typical electronic components such as resistors, capacitors, and inductors as well as MCU's such as the ESP32-WROOM-32D-N4 that we will be using for our project design. Simply searching the part number for your component will allow you to find and place the part into your design. Custom parts and components can also be placed into your circuit design. As mentioned before, a benefit to using Altium Circuit Maker is the ability to share and collaborate a project amongst others. Using the share function allows work to get done faster and for each group member to make modifications of their own in real time without having to send files back and forth or start the project from scratch each time.



Altium Circuit Maker also allows the user to see the PCB design in a three dimensional layout to give a better idea of what the PCB will look like once it is printed. The 3D model will also show any component violations such as overlap which is sometimes harder to notice when working in the 2D version. Similar to Autodesk Eagle, Altium Circuit Maker also uses the Push-N-Shove routing tool. Push-N-Shove allows for obstacle avoidance and ignorance. Traces can be pushed and hop-overs can be utilized. Schematics are easily shared, saved, and edited with the multi-sheet schematic editor.

The topological autorouter is an interesting tool within Altium Circuit Maker that looks at your design rules to help get the PCB design done in the most efficient way possible. Manual routing with auto-complete, multi-nets, and single nets can be used to interactively route the PCB design. With DRC/DFM validated outputs Altium Circuit Maker generates CAM outputs to aid in turning the design into a real PCB. DRC/DFM validated outputs ensure the board being designed abides by the specified design rules before going through the release process (48).

### **EasyEDA**

EasyEDA is another PCB circuit design software that we hadn't heard of until doing more research on different PCB design software. EasyEDA is meant to be a simplified PCB design software for beginners to help save time and not get lost in all the options that most PCB design software applications have. EasyEDA still has your essential PCB design tools such as schematic capture and PCB layout and simulation. Due to our limited PCB design experience this made EasyEDA a viable option to consider.

EasyEDA also has a free standard edition which allows the user to create unlimited private projects, personal libraries, and team collaboration. There is also a paid version of EasyEDA for \$9.90 a month which is significantly cheaper compared to other PCB design tools on the market. The main difference with the paid version is the option for quicker support from the company so the free version will suffice for us.

Similar to Altium Circuit Maker, EasyEDA allows for cloud storage for collaboration amongst the members of our team. EasyEDA is a browser application unlike Altium Circuit Maker and Autodesk Eagle which allows for easy web browsing for electronic components and for quicker cloud updating so our team can work on our circuit designs simultaneously.

Although EasyEDA is meant to be a simplified PCB design software for beginners, it still has all the features we would need to design our PCB. EasyEDA has schematic capture which allows for Spice-based simulations and models, a waveform viewer, export capability into spice Altium Circuit Maker and other PCB design softwares, BOM export, and multi-sheet schematics. EasyEDA also has PCB layout tools including the auto router, 3D design view, Altium Circuit Maker format export, photo view, and design files checking (DRC).

Altium Circuits and Autodesk Eagle circuits can also be imported into EasyEDA. EasyEDA also has an extensive library similar to that of Autodesk Eagle and Altium Circuit Maker. EasyEDA has over a million public libraries, spice symbol create and edit, as well

as footprint create and edit. Even though EasyEDA is viewed as the most simple PCB circuit design software compared to Autodesk Eagle and Altium Circuit Maker, we did not choose this as our PCB design software (49,50).

### **PCB Design Software Choice**

After using and comparing all of the PCB design software options we ended up using Altium Circuit Maker for our Senior Design project. We found Altium Circuit Maker to be the best option for our project due to its' vast selection of components in its' library as well as the ability to share and edit simultaneously within the cloud. David and Eltholad took the lead on the PCB and schematic design. Together we worked within Altium Circuit Maker to design the schematics for the audio amplifier and speaker connector, the LED driver circuit, the vibration motor circuit, the IR receiver circuit, the IR flashlight circuit, and the 3.3V and 5V regulator circuit.

### ***5.3.5 Summary of PCB Design Software***

The overall design of this something was initially difficult to narrow down since we wanted to implement something simple and cost effective. We are effectively designing two separate devices that operate within the scope of each other. It is imperative that our efforts in understanding and developing the tasks of each component and connection so that these devices can effectively work hand in hand. The process of building two devices means that we essentially will have two software models, two PCB design considerations, two microcontrollers and two hardware enclosure designs.

In order to reduce as much complexity as possible we decided to go the route of creating hardware that was fairly similar between the two devices. Meaning that we knowingly created designs for the IR Rifle and Target that could utilize the same main components. On both electrical systems we are using the same microcontroller (the ESP32), voltage regulators and voltage rails, and audio hardware. This approach allows for a large amount of the effort to be applied to one design, resulting in a faster turnaround. Also when troubleshooting and design changes are required the changes should only be small in scope.

We have employed a mobile phone to configure the two devices. We have laid out the plan that is shown in the later sections. Unfortunately the hardware enclosures and PCB designs for the two devices cannot fully take advantage of our standardized integration approach. To provide the best experience for the user both devices have their own sets of constraints and design goals. The target system enclosure was more flexible since it was 3D printed. Although, the target enclosure did take an adequate amount of time since multiple iterations were necessary. However, significant effort was initially placed into finding an adequate housing for the rifle hardware so a lot of our effort was put into adjusting this enclosure to satisfy our needs. Despite the task being substantial, laying out our design and design goals as we have provided a clear path towards prototype and software construction.

## 6.0 Prototype Construction and Operations

This section will detail the steps we plan on taking for building the prototype and will include Solidworks 3D models of our designs. We also include an “owner’s manual” providing instructions on how to use the prototype.

### 6.1 Laser Rifle Assembly

First, regarding the frame for the laser rifle, we bought one rather than constructed it ourselves, so many of our designs were working with the empty shell of the rifle. In our project, we heavily used heat-set threaded inserts for strong, reliable screw threads in 3D printed material. While you are able to print threaded holes using a 3D printer, these threads are not very strong nor accurate. Heat-set inserts on the other hand are threaded pieces of brass that are heated using a soldering iron and pressed into holes in a 3D printed part, causing the threads to melt the plastic around them. This creates a strong bond in the plastic while also allowing for screws to pass through the threads.

In **Figure 34** below, we provide a general layout of where each component is lying within the rifle. Due to the small space contained within the rifle frame, we moved the beam expander outside of the rifle with the idea that it would still have a fitting look for the rifle as a suppressor. The beam expander was a simple 3D printed tube that was fixed to the barrel of the rifle.

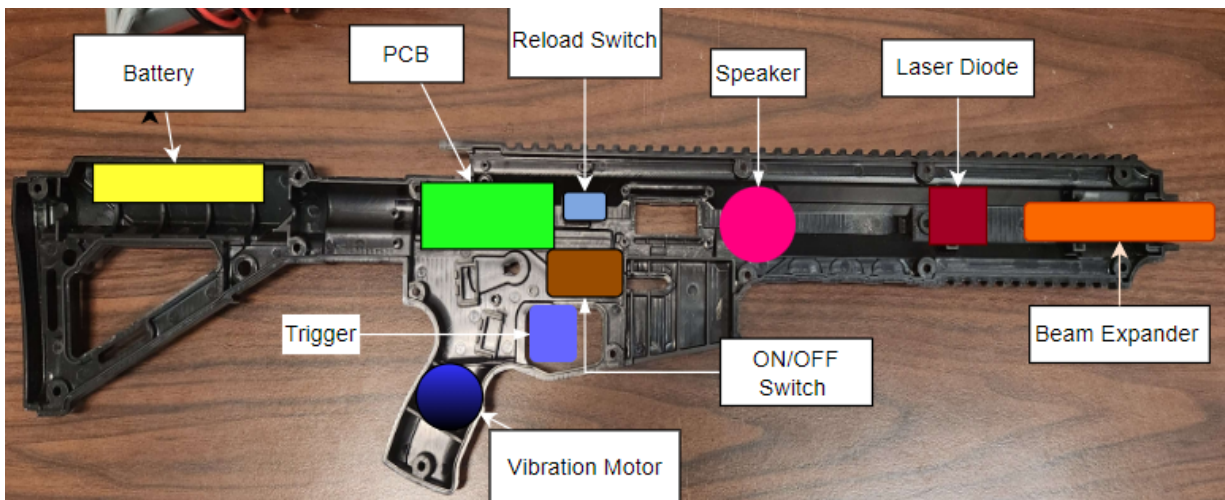

**Figure 34. Component Placement in Rifle**

#### 6.1.1 Rifle Attachments

Since the frame of the rifle was purchased, we had to make all of the housings for the attachments for the rifle such as the optical sights and flashlight. These designs were

made using Solidworks and made using a 3D printer. In **Figure 35** below, the preliminary design for the reflex sight is shown. It does not contain a battery holder for the LED. The LED is mounted into the hole shown in the image. Both the holder for the concave mirror and hole for the LED are angled in order to decrease the total amount of vertical space taken up by the sight. Since the LED has to be at the focal length (100mm) of the mirror for the light to be collimated and the mirror itself is quite large with a 62.5mm diameter, angling these elements makes the sight less bulky overall and more ergonomic.

We did not make a custom reticle, which would essentially be an aperture of some sort that is used to shape the light exiting the LED. Instead the illuminating LED itself would be the reticle. We used one of the 624 nm LEDs purchased for use in the target board in the reflex sight because they are quite powerful. The optical power emitted by the LED is highly relevant since the curved mirror only reflects ten percent of the incoming light. Picatinny rails, the standard rail system used for mounting attachments such as flashlights to firearms, were attached to the bottom of the sight for mounting to the rails of the rifle.

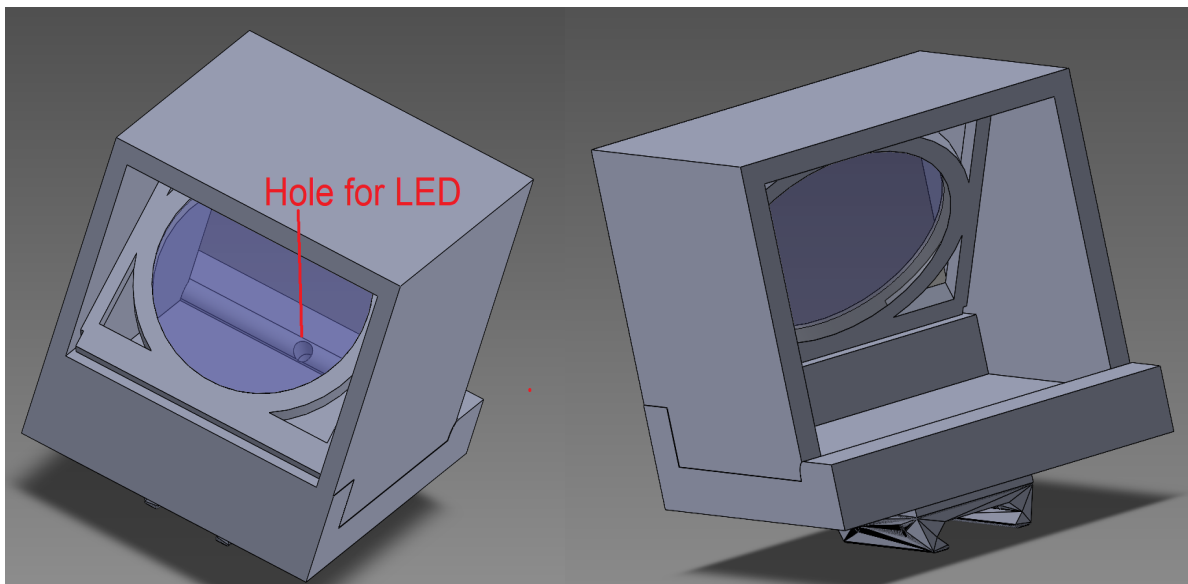

**Figure 35. Reflex Sight 3D Model**

The rifle scope was also 3D printed. The erector assembly was contained in a separate tube within the rifle scope that will be able to move around. As shown in **Figure 36**, there are several holes in the scope. These holes were used to place screws that gripped and held the lenses in place. In a rifle scope, there is a spring inside of the scope that keeps the erector tube in position while the elevation and windage knobs are used to control the position of the erector tube in the vertical and horizontal directions respectively. These knobs are typically used for calibration of the scope to make sure that the position of the shots you take are aligned with the reticle inside of the scope. For our scope, we used a pair of horizontal and a pair of vertical screws to adjust the position so that a spring was not needed.





**Figure 36. Rifle Scope Solidworks Model and Mounted**

The side focus lens was also in a separate tube that was moved back and forward to correct for parallax error. The erector tube was also planned to be movable along the axial direction in order for variable power to take place. Magnification adjustment rings on variable power scopes are quite complex to make, we ultimately had to remove the variable power feature from the design. With elevation and windage screws already being used to control the transversal position of the erector assembly tube, there was no way to be able to precisely control the tube's movement along the optical axis as well for three-dimensional movement.

The CMOS camera was installed directly into a 3D printed camera box along with the field of view changing camera lens system. The camera box mounted directly onto the eyepiece section of the scope using screws. The camera box was connected to the LCD display via RCA cables. An LCD display mount was made so that the display could be mounted to the side rails of the rifle. The camera and LCD display needed to run off a

separate 12V battery since they were designed to be removable, so we contained the battery within the camera box.

Construction wise, the IR flashlight was a simple device to build. It had a PCB with the 860 nm LEDs connected and a battery installed into the back end of the flashlight just like a standard flashlight you can buy on the market. Since the IR flashlight needed to have a variable focus, we used a setup like that of the side focus lens of the scope. A similar rail mount was made for the IR flashlight. Fortunately, if we had ever found that both the flashlight and display being mounted to the scope was too bulky, we could also mount it to the underbarrel of the rifle itself using the rifle's rail system.

## 6.2 Target Board Assembly

The target board was mainly 3D printed into two large parts that were combined after printing using screws. This is because the board is large at 210mm x 210mm, and there are two separate layers: the front surface and the back surface. The total thickness of the board not including lenses was designed to be 50mm. Both the front surface and back surface layer were 7.5mm thick. There is a 35mm spacing between the front and back surface that allows space for the PCBs and internal components of the target board to be mounted.

The back surface was just a simple flat board, while the front surface had a large hole where the PETG lenses could be installed into. The PETG lenses must be printed in very strict conditions in order to produce a usable lens, so we printed them separate from the rest of the target board system. We originally planned to have four different targets of sizes 25mm, 50mm, 75mm, and 100mm on the board but due to hardware limitations, we had to use a single receiver with a single 100mm hole in the lid. To remedy this problem, we used replaceable lenses to emulate having multiple target areas. Each lens, representing a target area, had a custom 100mm aperture ring that they were installed into. This made it so that we could easily change out a 100mm lens with any of the other size lenses. In **Figure 37**, the lens used is the 25mm lens placed in the 100mm hole.

Additionally, we applied a reflective coating using paint on the front surface of the target board before installing the lenses. Aside from aesthetic reasons, this is to assist the CMOS camera for night vision operation since most of the light coming from the IR flashlight will need to be reflected off the board for a good image. Of course, this will also decrease the amount of electrical power consumed by the flashlight since less optical power will be needed for sufficient lighting. We used a standard white spray paint.

We decided in the final design to use LED strips. The LED strips come with adhesive backs that attach to the surface, but we made indents in the surface of the target board lid to keep them from sticking out. There is a hole in the target board lid that connects the LED strips to the interior PCB via wire.

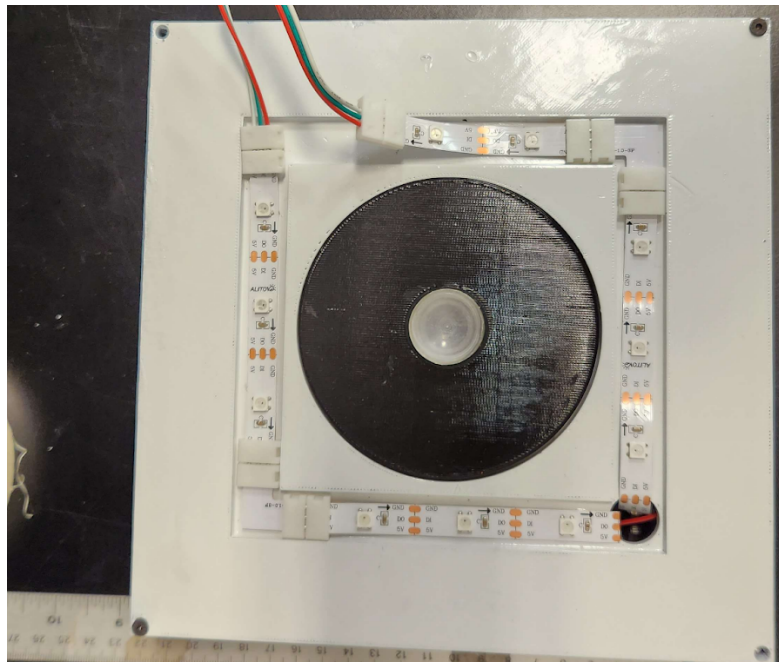
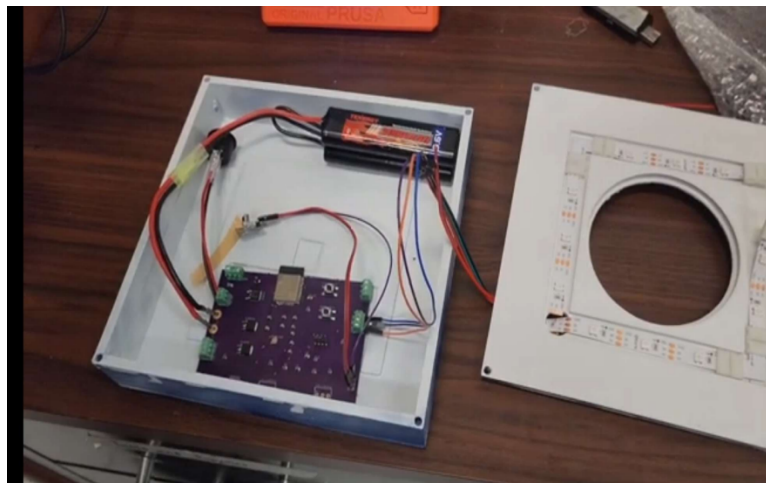

**Figure 37. Target Board Lid Off and On**

## **6.3 User's Manual**

In this section, we are presenting our project user's manual. The purpose of making this section is to present the project effectively. A major point of the user manual is educating people, and its importance for the user to be easily able to read, reference, and absorb the information clearer.



## Instructions for Software Use:

### First Time Setup:

First, click on the **FIND DEVICE** to start searching for Laser Rifle through Bluetooth. Depending on the device OS, a Bluetooth SETTING screen may show up. Find the device name “G6\_LaserRifle” and click on it. After doing so, switch back to the app. If the device is paired, the device name will appear in the app as shown in **Figure 38**.

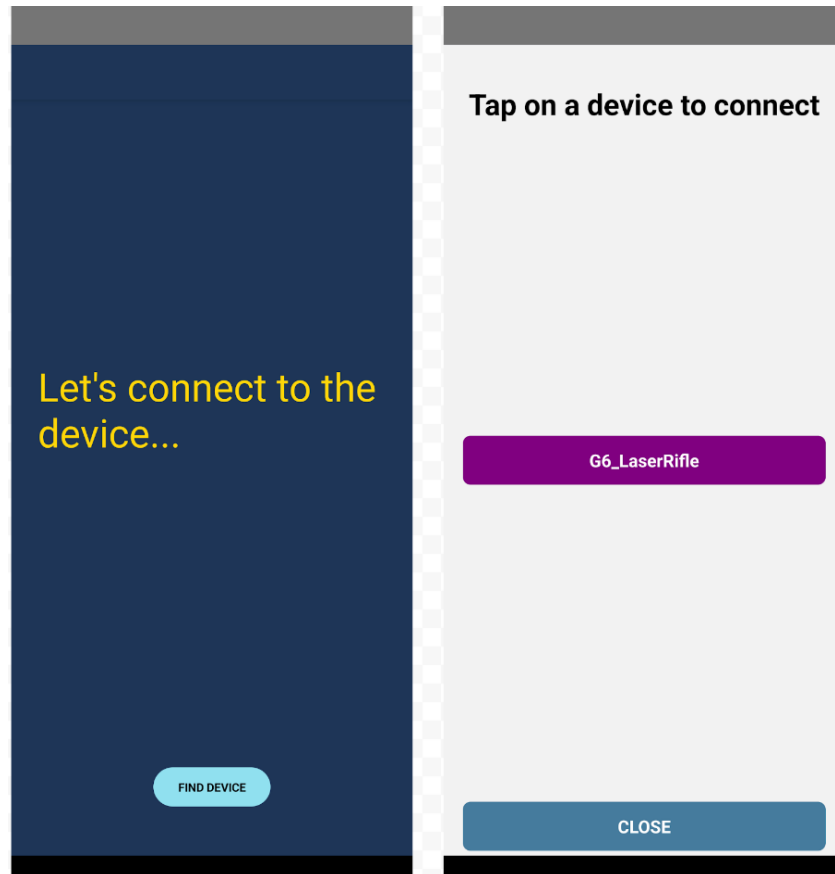

**Figure 38 - Device Paired Page**

When the device is found, tap the button to add the device. This will allow you to configure the Laser Rifle device using the app.

After pairing to the Laser Rifle, you will need to pair to the Target Board for configuration. Tap on the SETTING button at the bottom right. Then click the “PAIR A NEW DEVICE”. Find the device name “G6\_TargetBoard” and click on it. The following screens should be seen as shown in **Figure 39**.

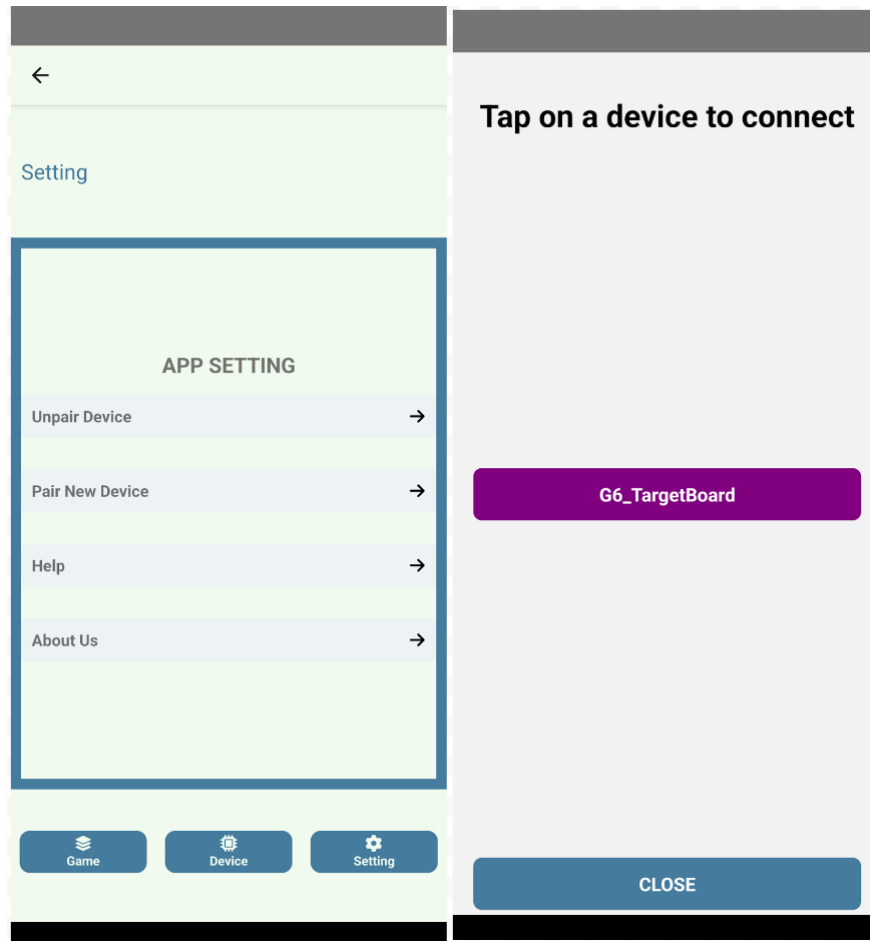

**Figure 39. Two Devices Paired Page**

Configure devices:

Once all devices are paired, you can now configure device settings. You can tap on the DEVICE button at the bottom to switch between different devices and change their individual settings as shown in **Figure 40**. You can customize the values for each device to a variety of presets. For the AR-15 Ranger Laser Rifle, you can change the RECOIL ACTUATOR which is changing the vibration pattern in of the three different preset settings. This includes TYPE 1, which is a short buzz, TYPE 2, a long buzz, and TYPE 3, a rapid buzz.

You will be able to view an AMMO counter on the main page. As you fire the rifle, it will tell you how many rounds you have remaining in your magazine. Once you fire your rifle enough to deplete the magazine entirely, the ammo counter on the app will automatically RELOADING in 5 seconds. While RELOADING, the player cannot fire their Laser Rifle.

There is also the sound customization of the rifle. The “SOUND” dropdown lets you choose a preset sound for the Laser Rifle. You can change the percentage of the Volume to suit your needs. You can change the Sound to be a laser gun sound or change to a different gunshot sound profile.

There are also the settings for the Target Board. The player can choose a preset timer for the Target Board. There are three preset timers: 10 seconds, 60 seconds, and 120 seconds.

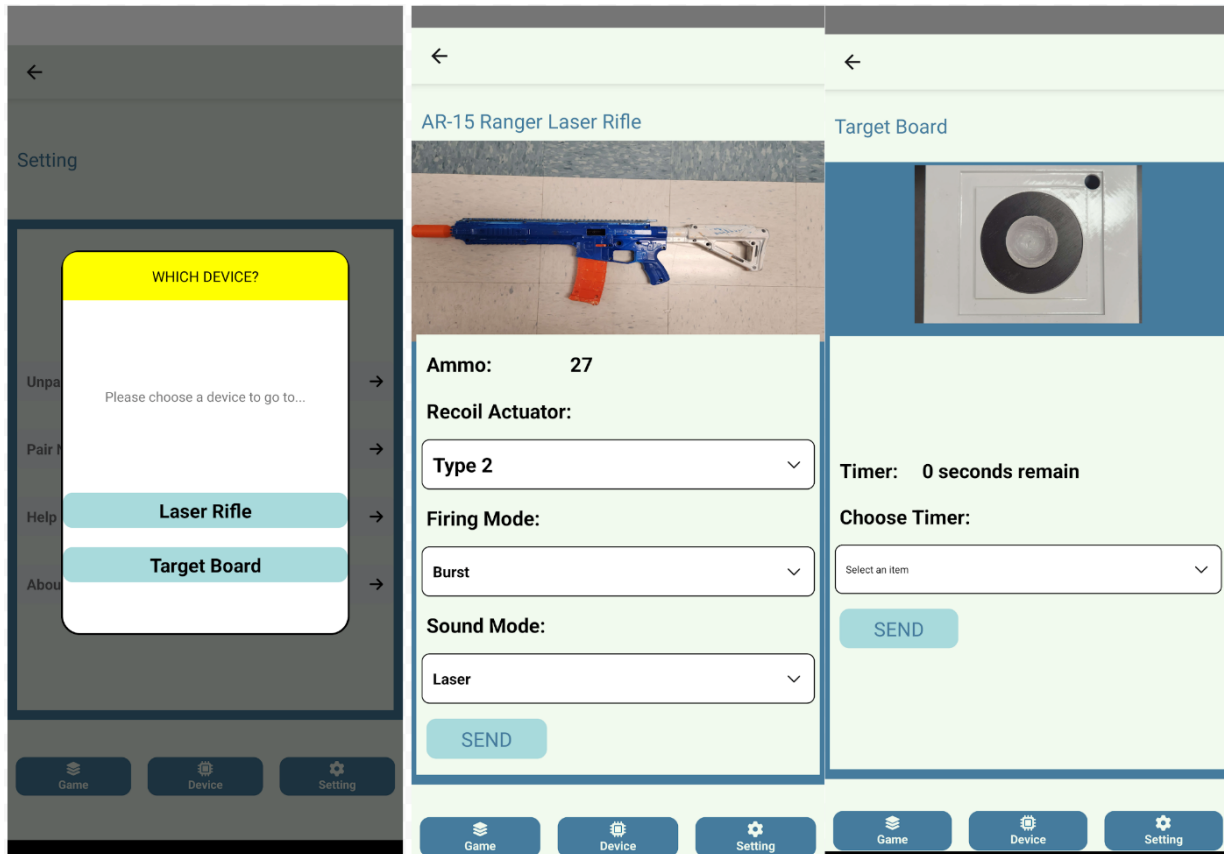

**Figure 40. Two Devices Configuration Page**

These are all the settings and information contained within the device configuration pages. Using the Laser Rifle, you should aim at the Target Board. When you shoot the target, the Target Board will light up its LEDs.

This concludes the operations manual for the core software.

### **6.3.1 User's Manual for Rifle Attachments**

In the case that separate rifle attachments would like to be used, these can be mounted by using the Picatinny rails on top of the laser rifle. This can be done using the screws built-in to the rail mounts of each optical sight and can be tightened using the associated Allen key.

After finishing mounting the optical sight, you can look through the sight and aim at the target. While aiming at the target, fire and see if your shot activates the target. Adjust the elevation and windage screws on the top and side of the optical sight to move the reticle of the sight until you are able to see the visible feedback from the target board. For higher accuracy, use the pinhole aperture blocker. Your sight is now calibrated and ready for use.

For the rifle scope, to adjust the position of the side focus lens, use the screws that are sticking out of the scope to adjust the axial position of the side focus lens. This should cause the focus of the system to change. Adjust the position so that the image is clearest when looking at objects that are very far away.

To use our custom night vision system, first mount the rifle scope onto the rifle's top rail. Carefully take the camera box and mount it to the eyepiece of the rifle scope. Then, take the LCD display and mount it to the side rails of the rifle scope using the rail system. Connect the cables between the display and the camera tube to begin streaming video to the display. The display should show the inside of the scope with the reticle.

To enable night vision functionality, the IR flashlight must be attached. This flashlight can be mounted to the side rails of the rifle using the picatinny rail connector just like the LCD display. Turn on the IR flashlight so that the target is illuminated. If you look at the video shown on the LCD display, you should be able to see light with a purple hue.

This is the infrared light being emitted by the IR flashlight. If the light is not strong enough or is causing saturation, you can adjust the focus of the light by using the screw on the front of the flashlight. This works exactly like the side focus adjuster and will expand the beam as you move the lens closer to you.

## **7.0 Prototype Testing**

In order to effectively evaluate various parts in our selection in both hardware and software components, we need to create testing scenarios for each particular section. In this section, we discuss the different ways we tested our design. Some of the information included in this section are the testing environments, our developing test rigs, lens testing, IR receiver testing, rifle scope testing, and unit test case for the software.

### **7.1 Hardware Testing Environment**

The main buildings used for testing are CREOL's Senior Design lab as well as the Engineering Building Senior Design lab. Within these facilities, basic electrical

components such as breadboards, resistors, capacitors, wires, etc are free to always use and available. Additionally, testing equipment such as oscilloscopes, digital multimeters, power supplies, optical power meters, and function generators are available for use.

Soldering equipment such as soldering irons as well as hot air soldering stations are available. 3D printers and computers are also available for use. Using these equipment's, we performed various tests for not only making prototype designs, but testing their optical or electrical performance as we will describe later in this section.

## 7.2 Hardware Testing

This section includes information about the overall hardware testing of our parts.

### 7.2.1 PETG Lens Testing

One of our first tests was to test making transparent PETG filament and making high power lenses using this filament. To confirm that the lenses we made function as lenses are not simple diffusers, we made a convex lens capable of focusing light. A 40mm focal length plano convex lens was designed and printed using a Prusa I3 MK3 3D printer. Using a layer height of 50 microns and 100%-layer infill, a 50mm diameter lens was printed over the span of 8 hours. The 3D printer was run overnight without supervision.

Extensive post-processing involved sanding from 400 grit to 1500 grit in increments of 200 grit, and after sanding to a smooth finish, the lens was polished using Novus #2 fine scratch remover with a Dremel tool. After post-processing was finished, the lens went from being a translucent diffuser to a transparent lens that could focus light.

**Figure 41** compares the planar surface of an unprocessed lens to that of the processed convex lens. It is not a surprise that the unprocessed lens acts like a diffuser based on the lack of uniformity in the surface. Looking at the yellow piece of paper underneath the lens shows that transmission through the diffuser is much lower.

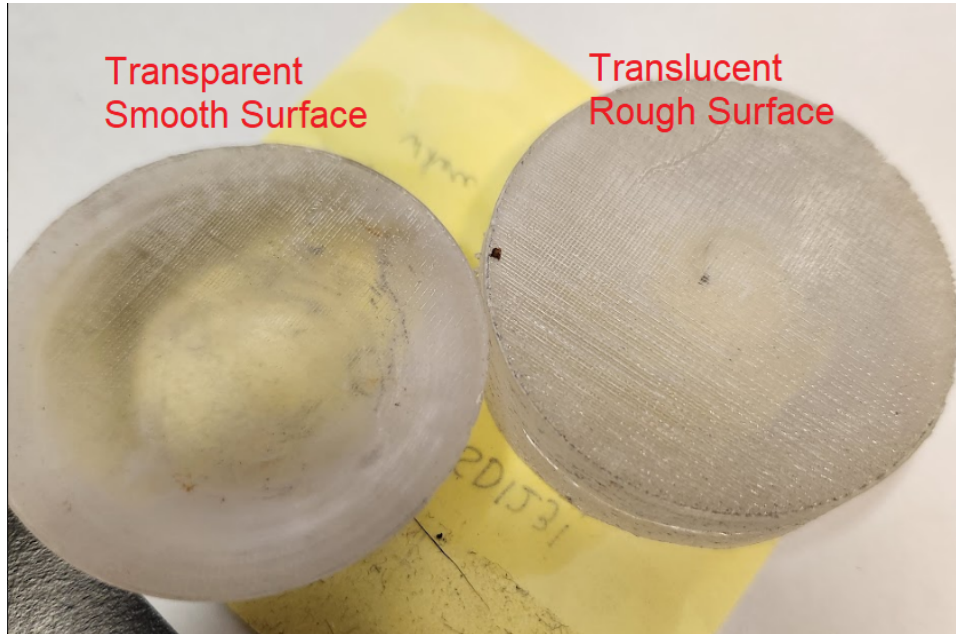

**Figure 41. Surface of Unprocessed vs Processed Lens**

In **Figure 42**, the performance tests for the lens are shown. As our goal with the lens was to prove that it actually functions as a lens and focuses light, we put the lens into the path of a laser to show the focusing capabilities of the lens. When tested using a power meter, the transmission through the lens was found to be around 50%. Since the post-processing was not perfect, light coming from positions far from the center of the lens suffered from moderate diffusion.

The lens also has losses due to surface reflections caused by the polishing compound used which is particularly obvious in the “At Focus” section of the figure. With more thorough polishing and sanding, the transmission can be increased even further. With this test finished, we know for certain that it is possible to make functional high power lenses using the 3D printer.

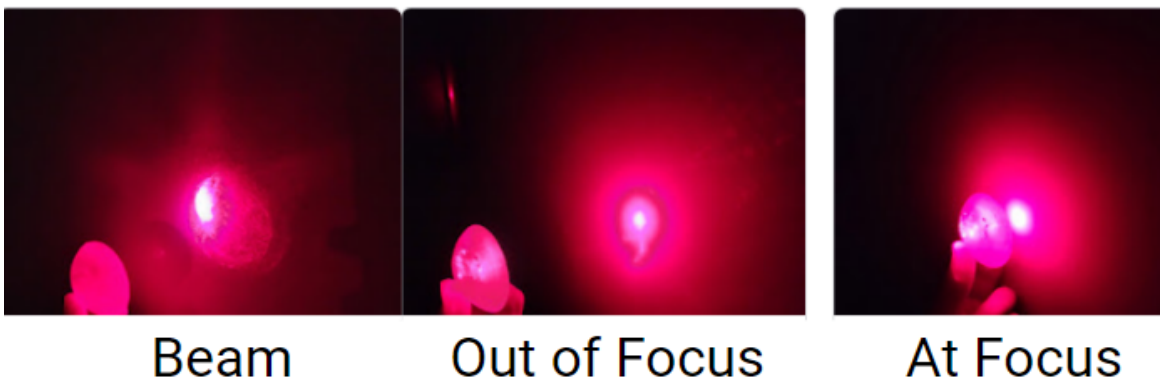

**Figure 42. PETG 40mm EFL Plano Convex Lens Testing**



With this knowledge, we made the 50 mm diameter plano concave lens with 60mm EFL that was displayed in the design section. We also made sure to measure the back focal distance from the wall to the planar side of the lens (35mm) to simulate how the beam will change size upon hitting the lens when installed into the target board. This test is important for determining how effective our lenses are.

We also provide a comparison to how the lens fresh off the 3D printer performs compared to the performance of the lens after being processed using the steps described above. The input beam was a laser pointer with a 1mm spot size. These results are shown in **Figure 43** with the processed lens clearly having a greater transmission, although there was still diffusion due to imperfections in the post processing process like in the case of the plano convex lens.

Based on the pictures in the figure, the processed lens also has a larger amount of reflection than the unprocessed lens while boasting an overall larger transmission. This could be due to the polishing compound used to polish the lens. Regardless, this could be beneficial for our project performance when considering the IR flashlight. The IR flashlight will shine light onto the targets themselves when used, so the increased reflections after processing will also improve the performance of the night vision system.

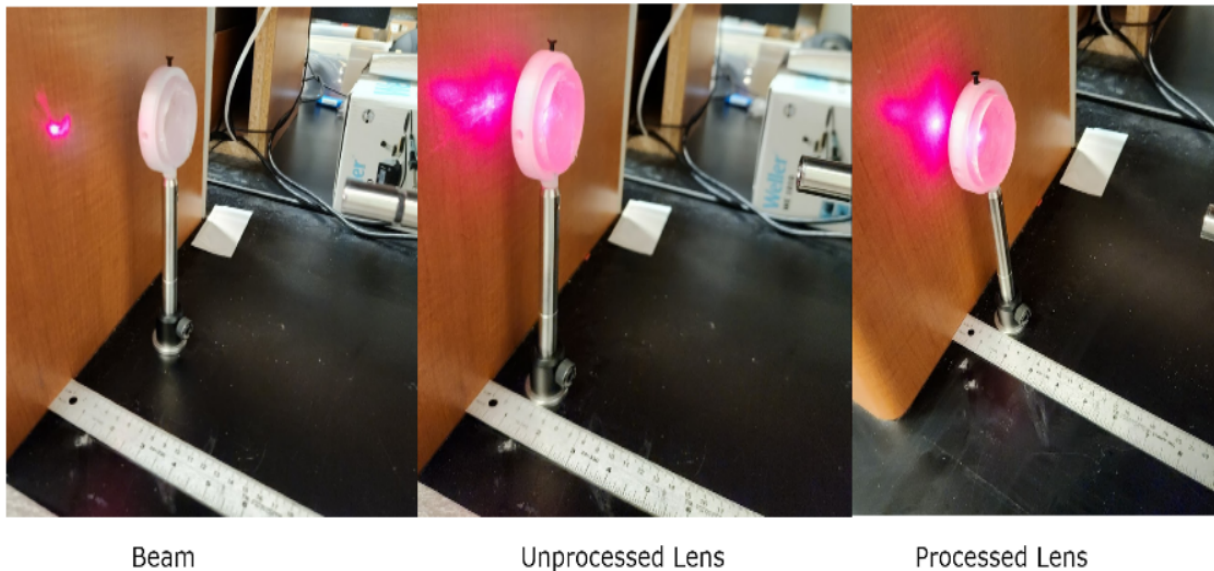

**Figure 43. PETG 60mm EFL Plano Concave Lens Testing**

### ***7.2.2 Laser Diode Testing***

We have performed various tests on the laser diode. We mainly made sure that the specs of the laser diode matched what was on the data sheet. When we originally tested it, we hand soldered wires on the laser diode which had greatly different results from what the diode should have been outputting. In future tests, we tried hot plates and reflow soldering



ovens and had results that matched what was listed on the data sheet. We tested using an optical power meter and measured output power to be correct for the typical current given on the datasheet. The divergence angle and beam diameter were tested using an IR viewing card to be 9 mrad and 3mm respectively which also aligned with what was stated on the datasheet.

### ***7.2.3 Visible LED Testing***

For the LEDs, these were tested for range and output power. Since our design was to be used at at least 15m, this was an obvious test since the LEDs must emit enough light to be visible from quite far away. Since these LEDs are entirely for visible feedback, many of the optical properties listed in the datasheets such as optical spectrum are not very relevant and did not require testing for the purpose of our system.

We also tested what distances we could view from and still see a bright light emitted by the LED with respect to the input current in order to determine the limitations of our system. Although the LED strips have a high viewing angle, the visible response was still quite visible even past 20m. In the prototype, we also measured the amount of time it takes for the LED to turn on after the laser strikes the IR receiver and found it was significantly below 1 second which met our requirement.

### ***7.2.4 IR Receiver Testing***

Using 940 nm LEDs, we performed tests on how to get the IR receiver to respond to the incoming modulated light. IR receivers typically respond to specific codes, or sequences, of modulated light that are pre-determined by the manufacturers of the receivers. For our system, we needed to test how we can encode one of these codes into the output of a 940 nm LED (or the laser diode), and then see how we can get the digital signal output that the receivers should output according to the datasheet. We were able to send different signals using a TV remote and get the IR receiver to send different LED strip responses using the microcontroller. After testing the receiver in different levels of darkness and active sunlight we found that it was indeed possible and simple to have the IR receivers pull in modified HEX signals. The signals are received and decoded almost instantly.

### ***7.2.5 Rifle Scope Testing***

In this section, there are five tests we have already performed on the rifle scope. These include light transmission, resolution, light gathering, field of view, and magnification tests. For the light transmission test, we simply put a 2mW 650nm laser through the system and measured the output power using a power meter. We observed that the light transmission through the system was 79.5% which is close to 80% like we had calculated beforehand.

The scope was tested for its angular resolution in different lighting conditions. The angular resolution is an important quality of the scope and determines how much detail can be discerned while using the scope to view an object. This is important since our target will

be at least 15m away from the user. In the worst case scenario, parts of the target board may not be clear while viewing with the scope if the angular resolution of the scope is too low.

Note that we specify “angular” resolution rather than spatial resolution because the system is afocal and does not have a strict working distance like when using a microscope. The different lighting conditions are important to test because this gives us a better understanding of the light gathering capabilities of our system. Larger amounts of light coming into the system result in a higher resolution image, and some scopes may be better at performing in low light conditions compared to others depending on the design used.

For our testing, we printed a 1951 USAF Resolution Test Chart shown in **Figure 44** (51). In this figure, we provide the different spatial resolutions that we were able to view in our testing along with a diagram for a conceptual understanding of resolution. We blurred the image of the test chart using image editing software to represent what we saw in our tests. Each set of lines has a different spatial resolution in line pairs/mm that can be converted into an angular resolution by using a simple trigonometric relation where the  $\text{angular\_resolution} = 2 \cdot \arctan((2 \cdot \text{line\_pairs\_per\_mm} \cdot \text{distance})^{-1})$ . In the test chart, the smaller the set of lines, the more line pairs/mm.

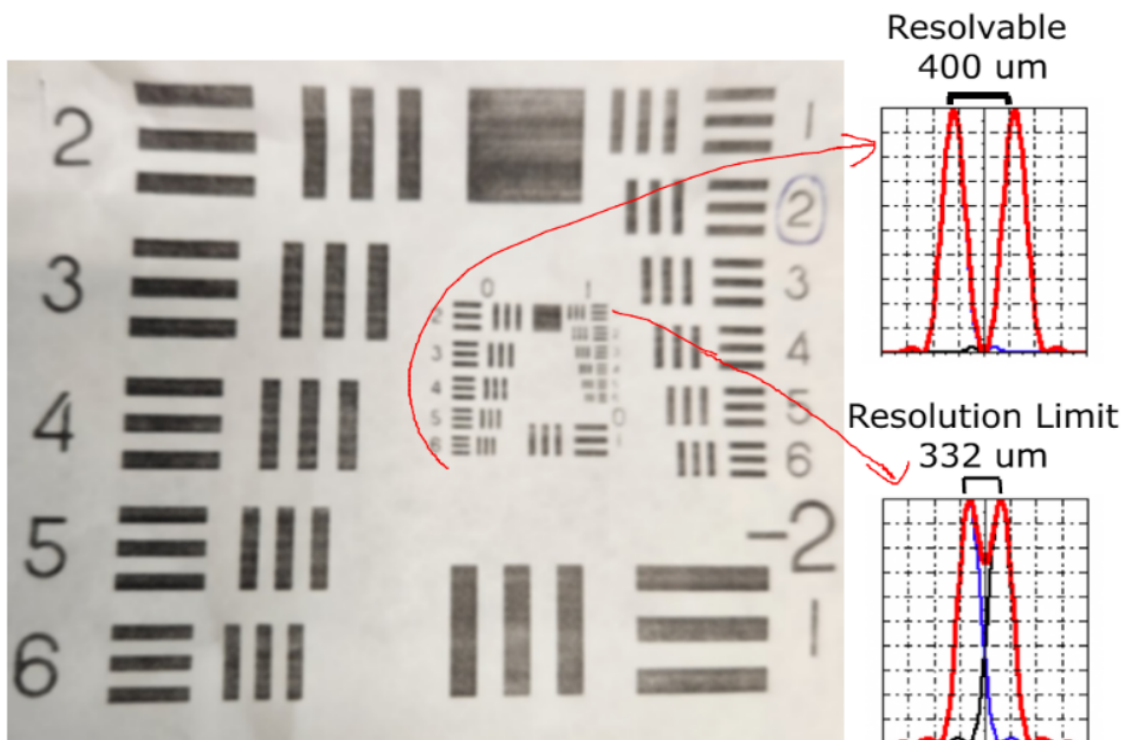

**Figure 44. Printed 1951 USAF Resolution Test Chart**

The angular resolution of our scope was tested by looking for the smallest set of lines that can be clearly distinguished while looking from a distance of 4m away. This means that

our results are entirely subjective and rely on the eyesight of the user. Rifle scopes and other afocal imaging systems typically are tested using special equipment to acquire the MTF of the system, but this kind of equipment is not something that we have available in our testing environment.

Since we printed an image of the chart rather than buying a test chart, the line pairs/mm corresponding to each set of lines of our chart is not the same as a commercially produced test chart. We measured the width of each line using an optical microscope in order to calculate the amount of line pairs/mm for our angular resolution calculations.

For the testing, we looked through the scope and looked for the smallest target (highest line pairs/mm) that is clearly distinguishable. This was tested across three different lighting environments. For each test, we took images using a smartphone camera looking through the scope when placed at the exit pupil to show how the resolution changes with the light.

We outlined the sets of lines where the resolution is limited in **Figure 45**. We looked through the scope beforehand to determine what was the most resolvable, so the camera pictures may not be perfectly clear. The large black lines intersecting on each image is the reticle of our scope that will be used for aiming with the scope.

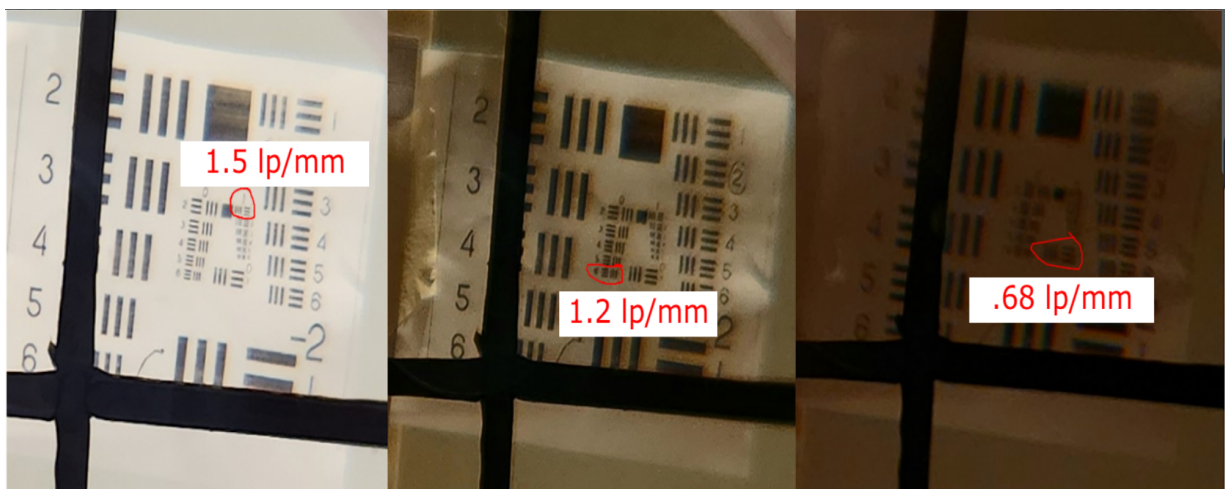

**Figure 45. Scope Resolution vs. Lighting Test**

For reference, the angular resolution limit of the human eye in peak condition (20/20 vision) is 1 arcminute, or 0.3 mrad. From our tests, we calculate that the angular resolution limit in these three different lighting conditions from brightest to dimmest are 0.16 mrad, 0.2 mrad, and 0.35 mrad. These results are relatively bad and can be because of a variety of different factors.

One reason is because the target distance is only 4m away, so the light coming from the object is not as close to paraxial as a target at 15m would be. To test this, we performed

two more tests at longer distances of 15m and 26m. In these tests, we were able to resolve at a 0.135 mrad angular resolution, which is better but still worse than our designed resolution. This shows that closer targets will have worse resolution.

Additionally, the next factor decreasing the resolution is the aperture stop size and alignment issues. Due to the size of the holders that we used and the methods we used to mount the lenses into the holders, the holders block some of the light, reducing the system numerical aperture. Increasing numerical aperture leads to more light collection and potentially higher resolution if the aberrations introduced by a larger aperture stop are not significant. A major factor affecting the results is the eyesight of the user; in other words, the resolution a user will perceive is entirely subjective. It is worth noting that the team member who carried out the resolution tests wears corrective eyeglasses.

We then measured the field of view of the system. We replaced the resolution test chart with a ruler to measure how much we can see when looking through the scope. This was tested at the 3m target distance as shown in **Figure 46**. This image also gives a better view of what the image outputted by the scope will look like in the prototype and shows a slight amount of chromatic aberration that was expected from the Zemax aberration chart. Using the ruler as a basis, the FOV of the scope can be calculated as 5.02 degrees. Commercial rifle scopes generally provide field of view in terms of feet per 100 yards, and research indicates that the FOV for a 4x rifle scope can range from 21 feet to 33 feet per 100 yards, or 4 degrees to 6.3 degrees. This means that our scope is quite average in terms of FOV.

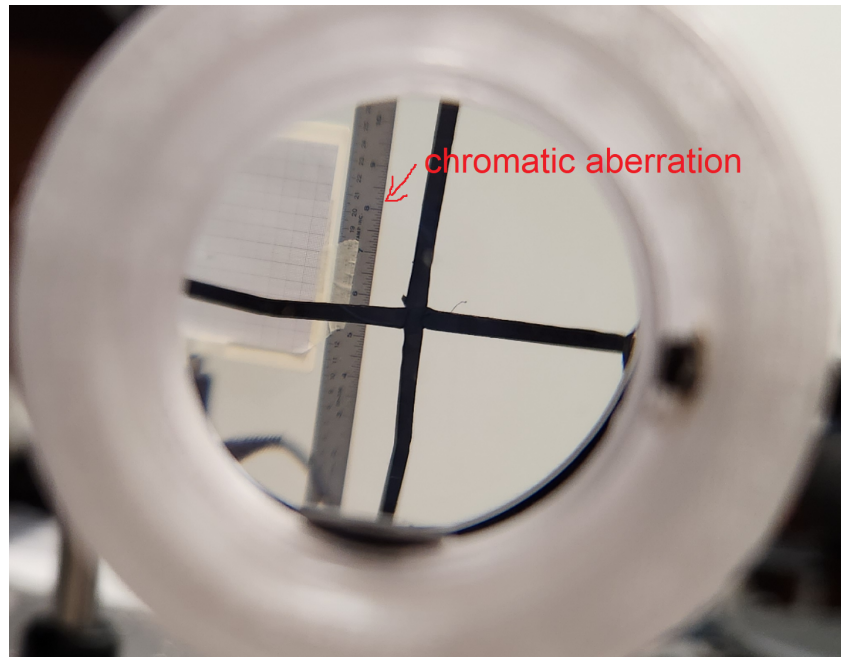

**Figure 46. Scope FOV Testing with Ruler**

Finally, we tested the variable magnification capabilities of the scope, although this proved to be a fruitless effort as we ended up removing the variable power feature in the



final design. The variable magnification comes from the shift of the position of the erector lens assembly. We designed our scope such that the maximum magnification is at 4x.

Therefore, we can only move our erector assembly towards the eyepiece, decreasing the magnification. In this test, we moved the target back to a 15m distance and observed how the magnification of the system changed as we moved the erector assembly closer to the eyepiece. These results are shown in **Figure 47** with the aiming reticle removed. As we expected, the resolution of the image will worsen significantly as you alter the magnification of the scope due to aberrations and the shifting exit pupil. This is an expected result as we had optimized our system for 4x. As seen in the 2x magnification image, the view through the scope becomes increasingly obstructed by the holders of the lenses. Although, the overall FOV increases.

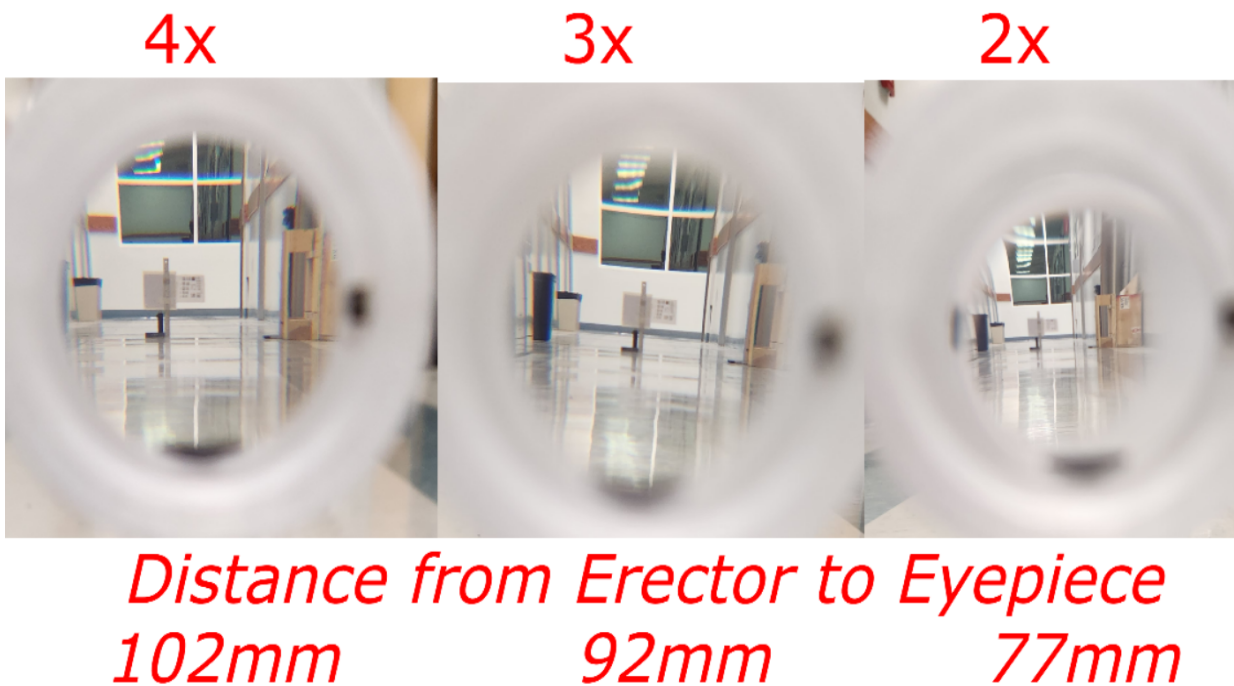

**Figure 47. Magnification vs Erector Assembly Displacement**

### **7.2.6 CMOS Camera and IR Flashlight Testing**

The 860 nm LEDs tie into the functionality of the CMOS camera as a night vision system. There is really no way to determine the amount of optical power needed to achieve a bright picture while using the CMOS camera without extensive testing. This is because the camera, which already has low quantum efficiency for the target wavelength, is creating an image based on reflections from a target that is going to be at least 15m away.

This is worsened further by reflections and other losses when passing through the rifle scope.

We originally planned to test by using different amounts of LEDs and input current into the flashlight, which can provide insight on how much optical power will be needed to properly use the CMOS camera for night vision. We also tried implementing reflective surfaces onto the target such as white spray paint or metallic paint to see if the camera will get a better picture. Additionally, the IR flashlight used a telescoping lens to change the focus of the 860 nm light, so we also wanted to determine how the focus of the light would impact the image output by the camera. In the end, we were never able to sufficiently test these parameters.

We have done basic tests showing how the lens system for the camera works to improve the resolution of the image while also decreasing the FOV. We placed the camera, which was connected and streaming video to the LCD display, so that it was looking through the scope at the same target we used in the Rifle Scope Testing section.

We moved the camera lens system in and out of the path of the camera in order to observe how the image streamed on the LCD display changed. The setup we used to perform these tests is shown in **Figure 48** below. We observed that the camera lens system significantly improved resolution and FOV decreased from 170 degrees to 110 degrees. These results are shown in **Figure 49**. Note that the quality of the picture is bad due to the smartphone camera used to take a picture of the display.

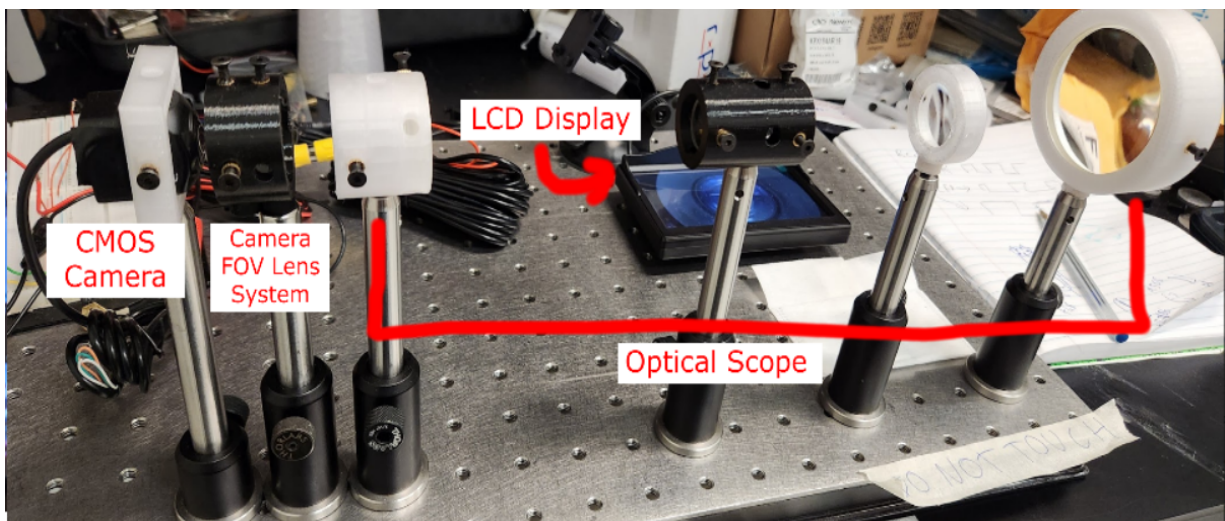

**Figure 48. Rifle Scope with Camera and Lens System**

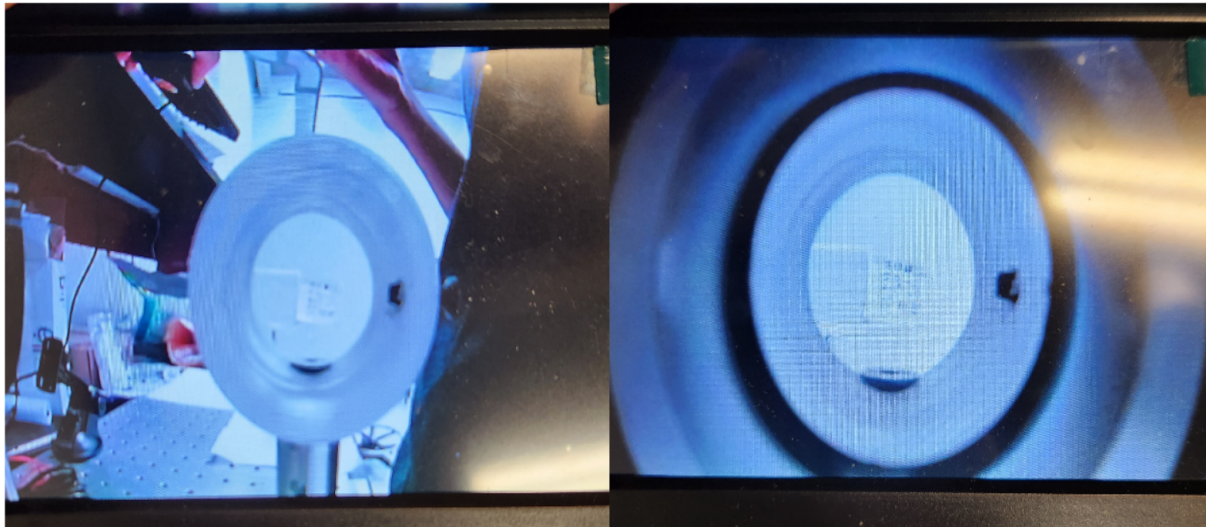

No Camera FOV Lens System

With Camera FOV Lens System

#### Figure 49. Camera FOV Lens System Testing

We have also done testing on the IR viewing capabilities of the camera-scope system. We turned off the lights in the test room and made a simple circuit to shine a single 860 nm LED onto the target. We placed the LED 2m away from the target and took a picture of the LCD display as shown in **Figure 50**. Like before, the image quality is poor due to the smartphone camera, with the quality being even worse since the image was taken in complete darkness.

This test shows why the variable focus on the flashlight is necessary in our project. Having too much light concentrated to a small area leads to a bright spot that makes it impossible to resolve any of the features of the image. Although we did test the transmission of the light through the whole camera-scope system, we were concerned about the feasibility of this part of the project since we did not have any information about the camera's sensitivity to IR light. When combined with the losses when transmitting through the rifle scope, we expected an image that would, overall, be much dimmer.





**Figure 50. Camera-Scope Night Vision Testing**

### ***7.2.7 Audio Testing***

The objective for this test should be to ensure that there are no compatibility issues between our audio system which includes the microcontroller, audio amplifier, and choice of speaker. Specifically we want to ensure that the playback of our chosen audio samples output with a high enough audio quality and timing precision so that when the laser rifle trigger is pulled the user can easily understand the sound effect being played under any condition.

The materials necessary for the test are pretty standard being that the entire audio system is only 3 components. The materials that were used for the test were the chosen microcontroller, ESP32, the Audio Breakout MAX98357A board, and both speakers that were discussed in the Audio Parts selection section, the one from Ada fruit and the MakerHawk from Amazon. These 3 major components in conjunction behavior are an ample representation of how the final audio system acts in our design. Lastly it is important to have a computer to compile and flash the audio test software, and a breadboard to wire the circuit together.

In order to test the audio we used using the necessary software that is compatible with the chosen microcontroller. We have found that the ESP8266 Audio library can produce and manage audio playback on our ESP32. The library is supposedly compatible with many microcontrollers that have similar processors including ours. We used a provided example file to test functionality of our audio system.

## 7.2.8 Wireless Communication Testing

The purpose of this test is to ensure the stability of Bluetooth communication of both devices. We write a small code to turn on the LED connected on the Target Board, and the Laser Rifle. Then, we can try to test the range of the Bluetooth communication between the devices and the mobile phone to see how far they could still stay connected. We also test the range of the device by finding the max range so that we know what the transmitter power and if it's necessary to raise the power to meet the necessary range or lowered if the range has already been met to lower power consumption.

Next, we test the quality of the data by going through a few several situations to find the limiting factors. We introduce a Microwave signal to see if that could affect the current bluetooth communication. Then we test with the dry heat, rain, sunshine, and EMF submission and emissions, conjoined with altitude and pressure to stress the quality of the connection.

## 7.2.9 Unit Testing

The purpose of unit testing is to test the quality of our code during the software development and embedded system development. When programming them, we have to assume that the behaviors of ESP32 microcontrollers and Arduino libraries to be either correct or at least *consistently* incorrect. What this means is that when our tests produce output contrary to our expectations, then we likely have a flaw in our code that was tested. If our test output matches the expectations, but the program does not behave correctly when we upload it to the ESP32, then we know for sure that our tests were based on incorrect assumptions and we likely have a flawed test. So that means the quality of our feedback has improved from "*something* is broken" to "*this specific code* is broken".

Based on our research, the ESP32 provides integration with the Unity unit test framework, which we could use to streamline writing tests for our software (15). They can be integrated into an ESP-IDF component by placing them in the component's "*test*" subdirectory. So by following this cited document, we can test the abilities of both our Laser Rifle and Target board software components.

## 7.2.10 Pairing Testing

From the READY state, our system should be able to successfully pair the Rifle. We will test our system by pairing two devices next, which are the Rifle and the Target board. Our targets should respond visually by turning green as they are paired. The controller screen should display the targets, indicating they have been successfully paired. If each target is successfully paired within 4 clicks, this test passes. The time from turning on the target and rifle system to pair to the mobile app and begin configurations was measured to be less than 5 seconds.

### ***7.2.11 Energy Testing***

One of the overall goals of our design is to provide a product that can operate efficiently. In order to do so we will be testing the current consumption of our system by sampling the 3.3V and 5V rails for our rifle and target systems while it is being operated. However, we were slightly confused on how to actually read these measurements while our system was running so we referenced a previous design group. To get these readings the group used a hall effect sensor at each voltage rail so that is the approach we will take for our testing method as well. If both systems are able to effectively run while only consuming 2800mA overall it will pass the energy test.

After completely setting up our system we found that since these devices are more so reactive than active systems their idle power consumption is effectively low. For the target board it was found that when not being stimulated by IR light the IR sensors draw little to no current. The same is said about the LED strips when a shooting round is not activated. On the rifle the vibrational motor, IR laser and draw negligible amounts of current as well. However, when connected we did find that even when idle the ESP32 chip does draw somewhere around 100mA due to the bluetooth connection and this goes for both the rifle and the target board. During a shooting round it is found that the IR rifle draws about 300mA while the target board draws about 180mA during use.

### ***7.2.12 Uptime Testing***

To do the uptime test, we will leave the microcontroller of the Rifle to be idling in the READY state for at least 4 hours and the Target board be idling at least 5 hours. If these conditions are met, this test case passes. We tested and verified the uptime engineering specification, and we successfully kept the Rifle running for over 4 hours and the target board running for over 5 hours.

### ***7.2.13 Range and Angle Testing***

One of our main design parameters is the ability to use the Rifle and Target Board system at long ranges. Therefore, it is only natural that we test the distance that the system will be able to properly operate at. This will rely on many different parameters including not limited to the IR laser diode power, transparency of the PETG lenses, presence of diffusion plates, and even depends on which target is being shot at since each lens has a different focal length.

Similarly, we can test to the maximum angle with respect to the surface of the Target Board. We mentioned that we would perform similar tests for the visible LEDs in the Target Board, but the testing mentioned in this section is exclusively talking about whether or not the IR receivers will be able to capture and use the IR laser diode signal at all.

#### ***Update***

We tested and verified the range engineering specification by making sure the target could recognize a rifle shot at a distance of greater than 15 meters. We also tested and verified the angle at which the IR receivers within the target board would capture a signal. The laser diode could be pointed at up to a 40 degree angle with respect to the lens and the IR receiver would still activate and show a response.

## 7.3 Software Prototype

### 7.3.1 User Interfaces Design

**Figure 51** is the home page when the program is first started. In the picture, there is a “FIND DEVICES” button to pair the Rifle or the Target. The app gets the Bluetooth permission of the device and then only compatible devices will show up in the device list and populate in the app.

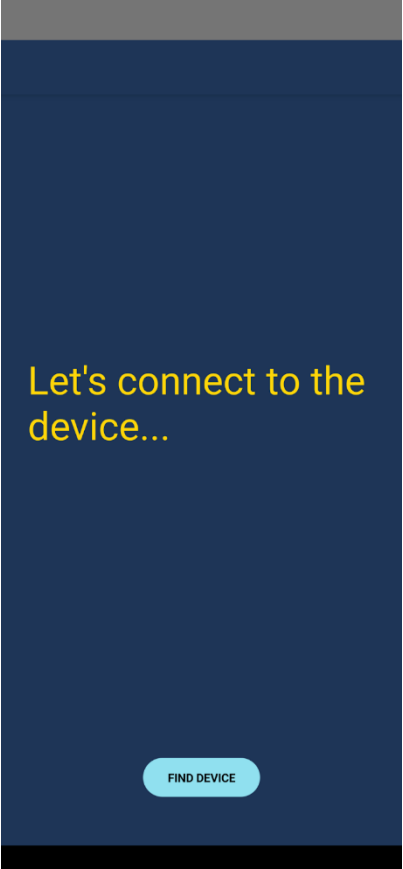
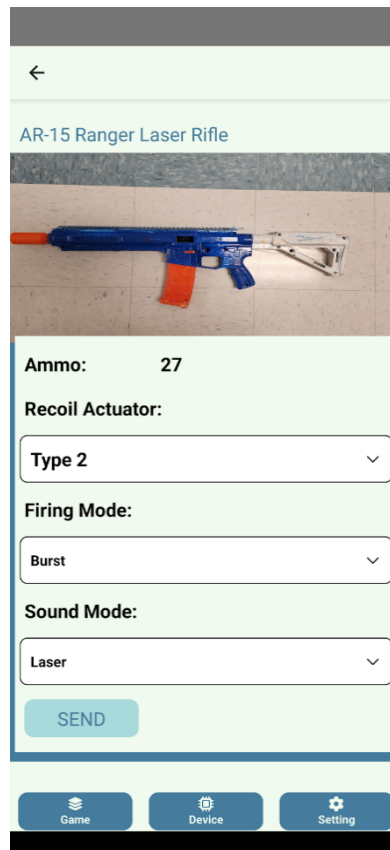

**Figure 51. Find Device Page**

After the pairing process is finished, **Figure 52** below shows the main page of the app. The current screen shows the information about the Laser Rifle: what is the type of the

recoil actuator, the ammo count, the current firing mode, and the current volume percentage. Recoil Actuator Type is an element that can be configured by this app. We have multiple types of the recoil value. Since there's a built-in vibration motor in the Laser Rifle, each type will represent a different vibration pattern when the trigger of the gun is pressed.

The Ammo element is a real-time counter that records the virtual magazine round number. When the trigger is pressed, the counter will be decremented until it reaches zero. And when the number reaches zero, it will show the RELOAD state. The Laser Rifle will need to manually reload the round with a press of a button, and the counter will reset back to the original number, and in this case it will be 30. Sound Mode element is showing the current sound effect outputting from the Rifle speaker. The app can change this element and can be configured into another sound effect. This element will be a user customizable feature to the user's liking.



**Figure 52. Gun Page Information**

The **Figure 53** below shows the target board page after pairing it to the mobile app. Similar to the Laser Rifle information page, the page shows the information about the Target: The Timer Counter, the dropdown option for the timer. The user will have a preset

timer that they can choose to set for the Target Board. While the timer is running, the player can begin shooting their laser at the board, and the visual response on that target board will light up their LED color respectively.

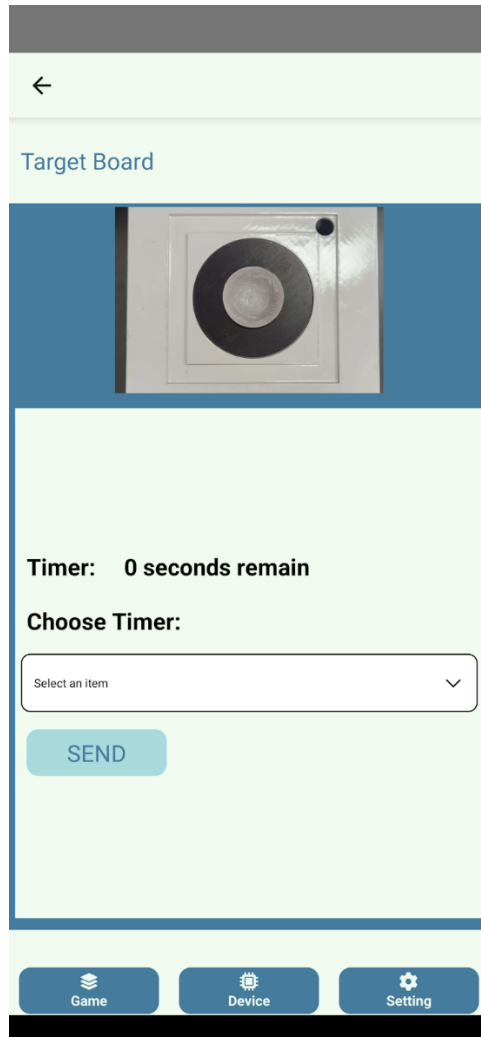

**Figure 53. Target Board Information**

### **The Game Mode**

In the PLAY state, the view the user will see on the mobile app will depend on the selected game mode. There are three different game modes: Time Attack, Reaction Mode, and Score Attack. In all game modes, the user will be able to see the number of targets they have successfully hit. In Time Attack and Score Attack, the user will also be able to see their remaining time. In Reaction Mode, the user will be able to see how fast they have

completed the game, testing their accuracy and reaction time. The associated views for each of these gameplay modes are shown in **Figure 54**.

### **Time Attack**

When the game begins, the timer will start counting down from the timer counter. There is a random chance for different Target Board controllers to trigger the LED\_STATUS to ON. The user must shoot the correct Target to score. A correct Target shot will reward them a score. After the timer hits zero, the game will stop, and the user can see the score result afterward on the mobile application.

### **Reaction Mode**

When the game begins, there is a random chance for three different Target Board controllers to trigger the LED\_STATUS to ON. Then, the Timer will start counting in the unit second. The user must be quick and accurately hit all three lit Targets to end the game. The Reaction Time Score will be shown after the game is over. If the user did not hit the target accurately, the Target will stay lit until the user hits it accurately.

### **Score Attack**

When the game begins, all four Targets LED are lit up. The user needs to accumulate points by shooting at any Target multiple times and accurately before the timer of the Target controller reaches zero. The Target that has less points (i.e., 5 pts Target) will require fewer shots than the Target that has most points (i.e., 20 pts Target).

If the user did not hit the target accurately, the Target will stay lit until the user shot it accurately. The Target LED\_STATUS switches to OFF after the number of shots has been reached, and after 2 seconds, the Target LED\_STATUS switches to ON again and can be shot at it again. When the timer reaches zero, the game is over, and the final Score will be shown to the user on the mobile application.



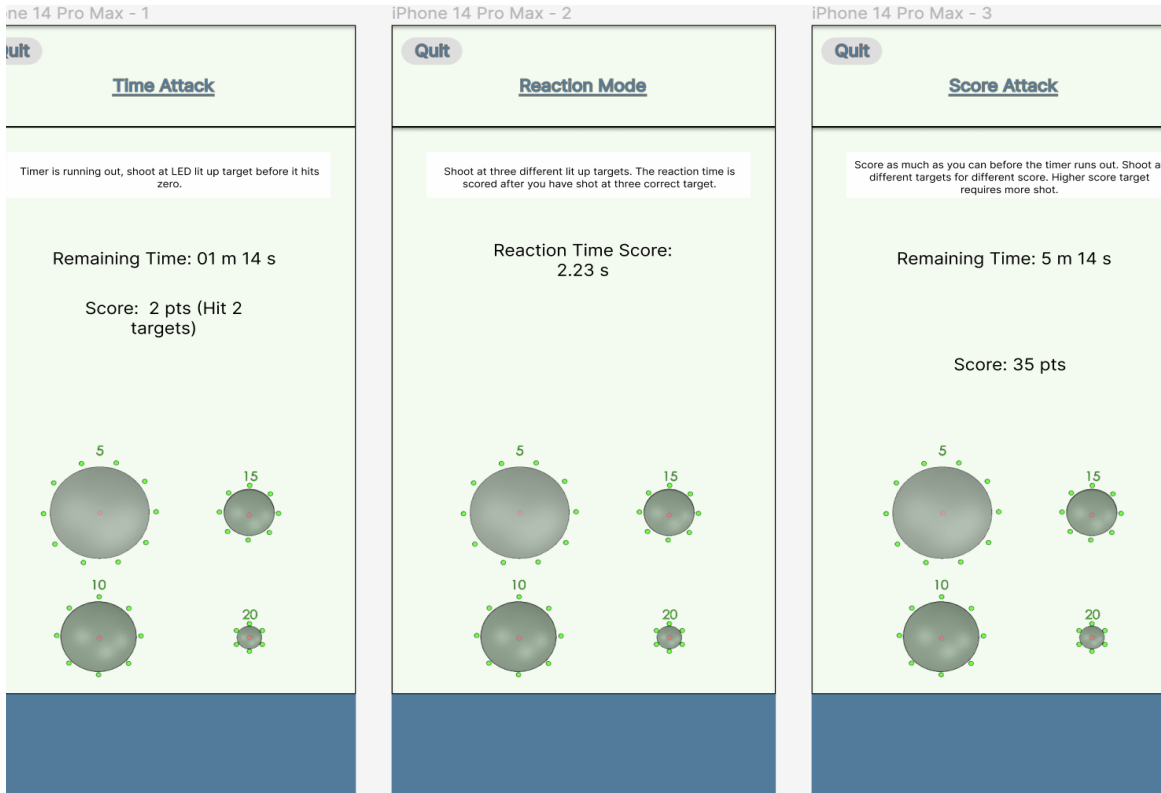

**Figure 54: User Interface of Each Game Mode in the Play State**

In each GAME MODE, the user may also decide to quit the game. To reach this option, the user can click the left input button next to the QUIT option on the screen. This will trigger the Exit Confirmation screen, which will give the user the option to quit or continue the game by clicking the left or right input buttons respectively as can be seen in **Figure 55** below. Once gameplay has ended, the user can view their game mode and final score. The user can confirm their results and request a reset by clicking the left input button, which will return the controller to its READY state.

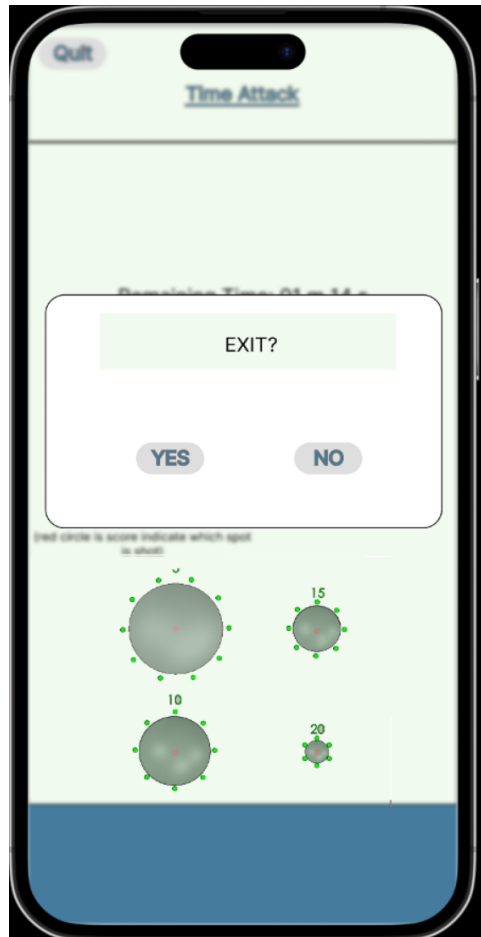

**Figure 55: User Interface for Game Exit in the Play State**

### Update

These figures are old and outdated, but we did make efforts to try to implement these game modes feature despite the final design having to get rid of these features unfortunately.

### **7.3.2 System Features Design**

The **Figure 56** below shows every state of the entire system including during the gameplay that both Laser Rifle and Target Board would be in. The illustration is the finite state machine system that can very well explain the behavior of every state when the system shifts into states according to the user input or other environmental factors. In this example illustration, there are four states: PAIRING, READY, PLAY and END denoted by

circles. Each state takes some type of input representing a transition arrow, and then outputs the result from one state to another followed by another transition arrow.

The PAIRING state is a start state where the Laser Rifle and the Target board begin the pairing request with the mobile application, connecting and communicating with each other. Once the pairing is established, it shifts its state to the READY state the system is waiting for user input or new instructions while maintaining consistent connections. On the mobile application, the user chooses the gameplay mode, and then the system will switch to the PLAY state indicating a game is currently running.

If the game event has come to an end or is being interrupted somehow, then the system will switch to the END state which is also known as the accept state, denoted graphically by a double circle. For example, the input is “Game starts, Game ends, Game resets, Game starts, Game ends” then it would lead to the state sequence as READY, PLAY, END, READY, PLAY, END and is hence accepted.

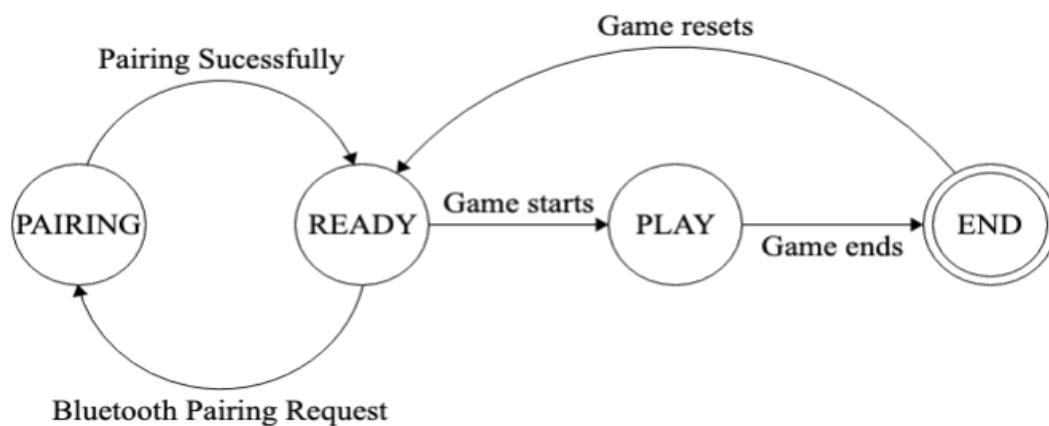

Figure 56. Laser Rifle and Target Board MCU State Machine Diagram

## 8.0 Administrative Content

To ensure the best chance of project success, our team developed a set of project deadlines, milestones, and associated budget. This section deals with the managing aspects of our project. We will first discuss the budget on how we managed to purchase parts and more details, then we talk about the scheduling and milestones to be broken down into a set of tasks and when we completed the tasks.

## 8.1 Bill of Materials

This project was self-funded by the group, with costs being split evenly among each group member. In **Table 10**, an expected cost for each item, the actual price of the item, and quantity of the item that we purchased is provided. We bought extra parts for testing purposes and as backups. These prices are reflected in the table. We calculated the total amount of money spent and we were within the total budget that we set for the project.

Item Type	Expected (\$)	Actual (\$)	Quantity
Rifle Frame	100	230	1
IR Laser Diodes	75	150	10
Visible Laser Diode (no longer being used)	20	12	30
Lenses	300	100	30
CMOS Camera	50	40	1
LEDs	40	30	100
Clear PETG	100	40	2
Black PLA		17	1
IR Receivers	40	18	25
Batteries	60	17	2
Speaker	10	9	2
PCB	40	MISC	5
MCU	16	8	2
MCU Dev Board	16	16	2
Vibration Motors	10	13	15
Misc. Components	40	MISC	MISC
<b>Total</b>	<b>\$917</b>	<b>\$700+MISC</b>	

**Table 10. Bill of Materials**

## 8.2 Scheduling and Milestones

Project deliverables and milestones for the Fall 2022 and Spring 2023 semester are shown in **Table 11** and **Table 12** respectively. For the Fall 2022, each milestone is listed along with the time it is to be completed. Each milestone is further broken into a set of tasks: how much progress has been completed on the task and when each task should be started and finished. These tables were updated as deliverables were completed.

<b>Task</b>	<b>Start</b>	<b>End</b>	<b>Status</b>
<b>Early Stage/Bootcamp</b>			
<b>Form Groups</b>	<b>8/23/22</b>	<b>8/30/22</b>	<b>Complete</b>
<b>Discuss Project Idea</b>	<b>8/30/22</b>	<b>9/1/22</b>	<b>Complete</b>
<b>Decide Meeting Schedule</b>	<b>9/1/22</b>	<b>9/1/22</b>	<b>Complete</b>
<b>Divide and Conquer 1.0 9/16</b>			
<b>Finalize Project Idea choice</b>	<b>9/1/22</b>	<b>9/6/22</b>	<b>Complete</b>
<b>Determine Budget</b>	<b>9/6/22</b>	<b>9/12/22</b>	<b>Complete</b>
<b>Hardware Diagram</b>	<b>9/6/22</b>	<b>9/13/22</b>	<b>Complete</b>
<b>Determine Objectives</b>	<b>9/6/22</b>	<b>9/13/22</b>	<b>Complete</b>
<b>Determine Standards</b>	<b>9/6/22</b>	<b>9/13/22</b>	<b>Complete</b>
<b>Determine Specifications</b>	<b>9/6/22</b>	<b>9/12/22</b>	<b>Complete</b>
<b>Divide and Conquer 2.0 9/30</b>			
<b>Group 6 DCV1 Meeting</b>	<b>9/21/22</b>		<b>Complete</b>
<b>Refine Goals, Constraints and Standards</b>	<b>9/21/22</b>	<b>9/30/22</b>	<b>Complete</b>
<b>Apply changes discussed in DCV1 Meeting</b>	<b>9/21/22</b>	<b>9/30/22</b>	<b>Complete</b>
<b>Create House of Quality</b>	<b>9/21/22</b>	<b>9/30/22</b>	<b>Complete</b>
<b>60 Page Draft Document 11/4</b>			
<b>Research and Document work</b>	<b>9/30/22</b>	<b>11/4/22</b>	<b>Complete</b>
<b>Refine Requirements, Constraints and Standards</b>	<b>9/30/22</b>	<b>11/4/22</b>	<b>Complete</b>

Create Hardware Schematic	9/30/22	11/4/22	Complete
Create Hardware Testing Plan	9/30/22	11/4/22	Complete
Create Software Testing Plan	9/30/22	11/4/22	Complete
Design Mobile App	9/30/22	11/4/22	Complete
Wireless Considerations	9/30/22	11/4/22	Complete
Software to Hardware Integration Plan	9/30/22	11/4/22	Complete
Select Parts	9/30/22	11/4/22	Complete
Order Parts	9/30/22	11/4/22	Complete
<b>100 Page Draft 11/18</b>			
Parts Testing and documentation	11/4/22	11/18/22	Complete
Hardware Prototype Assembly Plan	11/4/22	11/18/22	Complete
Software Prototype Assembly Plan	11/4/22	11/18/22	Complete
<b>Final Document 12/6</b>			
Build and Test Hardware Prototype	11/4/22	12/30/22	Complete
Build and Test Software Prototype	11/4/22	12/30/22	Complete

**Table 11. Fall 2022 Project Milestones**

<b>Task</b>	<b>Deadline</b>	<b>Status</b>
<b>SD2 CDR</b>		
Continue Hardware Prototype Testing	1/23/23	Complete
Final Component and Design Tuning	1/23/23	Complete
Work on Prototype PCB	1/30/23	Complete
Work on Presentations	2/3/23	Complete
<b>SD2 Midterm Demo</b>		



<b>Finish Hardware and PCB Assembly</b>	<b>2/24/23</b>	<b>Complete</b>
<b>Finish Core Software</b>	<b>2/24/23</b>	<b>Complete</b>
<b>Integrate Hardware and Software</b>	<b>3/14/23</b>	<b>Complete</b>
<b>Make Demo Video</b>	<b>3/22/23</b>	<b>Complete</b>
<b>SD2 Final Demo</b>		
<b>Finish All Software</b>	<b>4/3/23</b>	<b>Complete</b>
<b>Fine Tune Hardware</b>	<b>4/3/23</b>	<b>Complete</b>
<b>Add Stretch goal features</b>	<b>4/10/23</b>	<b>Complete</b>
<b>Final System Testing and Revisions</b>	<b>4/14/23</b>	<b>Complete</b>
<b>Create Presentation</b>	<b>4/18/23</b>	<b>Complete</b>
<b>Create Demo Video</b>	<b>4/18/23</b>	<b>Complete</b>
<b>Create Website</b>	<b>4/25/23</b>	<b>Complete</b>
<b>Finish Final Presentation</b>	<b>4/25/23</b>	<b>Complete</b>

**Table 12. Spring 2023 Project Milestones**

## 9. Summary

This section includes a summary of the different parts making up our project, how our project could be improved further, and a conclusion reflecting on what we have learned and experienced throughout this course.

### 9.1 Project Summary

In our project, we took the pastime of target shooting and added lasers, electronics, and software to the mix. Our project designs lead to a safer and more consumer-friendly alternative to traditional target shooting by creating a highly customizable but portable laser-target system that can be used virtually anywhere regardless of the time of day. Combined with our unique target board system lens system and IR receivers, our laser-target shooting system becomes heavily resistant to optical noise and quickly gives visible LED feedback to the user when a shot is made.

With software, we also implemented different features that allow the system to be used for pure entertainment or for training yourself in handling firearms. To make our system even more versatile, we went further and designed a variable zoom rifle scope that can be used at long range while also acting as the foundation of a night vision system.

With the combination of a camera, LCD display, and IR flashlight, we can convert our rifle scope into a night vision scope. Ultimately, our project is an incredibly versatile and portable system that can be used in a variety of different ways to satisfy the needs of the consumer.

### 9.2 Future Improvements

Due to time constraints and other problems, we came across, some of the features that we hoped that we would be able to add in the final design were not able to be realized. We were unable to fully integrate game modes into our design and would like to do so in a future project. We also believe that implementing custom recoil patterns using stronger vibrational motors would better fit our rifle experience.

We would have also enjoyed allowing more customization options for the target board LEDs as the LED strips were completely programmable. We would also like to be able to implement our stretch goals for a safer and more customizable experience. We also would consider making our own 3D printed rifle frame.

Although it could be a lot more difficult to get the design to be perfectly functional, we believe that this would be better in the long run as spatial constraints played an unexpectedly large role in our designs even down to how we made our PCB dimensions.

## 9.3 Concluding Thoughts

This is our conclusion to the entire project, and here are a few key takeaways from the Senior Design class. We have learned how to turn our simple idea into a full design, which was incredibly challenging. However, this challenge is an important learning experience for us engineers. By doing all the research and writing needed to complete our paper for Senior Design 1 and the implementation in Senior Design 2, our group members have all learned several important skills that will be useful to us as we pursue our engineering careers.

These skills include but are not limited to working as a team, taking a project from a simple idea to a detailed design plan, part research and selection, and software design planning for several hardware components and the mobile phone application, and PCB schematic design process.

Along with these fundamental engineering design skills, we have also developed our own individual skill sets to support the group effort. Before Senior Design 1, none of our members had any real experience with Solidworks and making models for 3D printing, but as seen from our project documentation, the use of this program has become a major foundation of our project. This is just one of many examples of something that we have been pushed to learn ourselves to succeed.

One of the most valuable of these skills that we have gained is the ability to work with a team with different skill sets and backgrounds. We also were able to work on a project that requires a significant amount of planning and design. This is something we will be required to do every day in our career, and therefore this is why we need to get practice and apply our knowledge while we are still in college.

We have learned how to make educated compromises in the design process so that our decisions will work for everyone in the group and not just ourselves. This will help to make everyone take advantage of their strongest skills and expertises, and the workload becomes more balanced.

Most of our group members have never created an engineering project at this scale from start to finish, and we are proud to see the end result of our hard work. We have spent unforgettable moments bonding and struggling as a team to overcome the challenges that we came across during the span of our project. We hope that this will reflect positively on us as part of our legacy at UCF as we move on to our engineering careers.

# Appendices

## Appendix A: References

- (1) Everlight-Elec-IRM-3638JF  
[https://datasheet.lcsc.com/lcsc/2103191537\\_Everlight-Elec-IRM-3638JF\\_C2759910.pdf](https://datasheet.lcsc.com/lcsc/2103191537_Everlight-Elec-IRM-3638JF_C2759910.pdf)
- (2) Strikeman Laser Firearm Training System  
[https://www.strikeman.io/products/shop?gclid=Cj0KCQiA7bucBhCeARIsAIOwr-\\_wtYBRQmlsAZYI xv2ao7QJZyHqH6liHJii-buQb3mz7vX9iLYeJ1YaApGjEALw\\_wcB](https://www.strikeman.io/products/shop?gclid=Cj0KCQiA7bucBhCeARIsAIOwr-_wtYBRQmlsAZYI xv2ao7QJZyHqH6liHJii-buQb3mz7vX9iLYeJ1YaApGjEALw_wcB)
- (3) LaserHIT <https://www.laserhit.com/>
- (4) LaserShot <https://www.lasershot.com/>
- (5) LaserLyte <https://laserlyte.com/>
- (6) Laser Skeet <https://www.ece.ucf.edu/seniordesign/fa2017sp2018/g08/>
- (7) Eye-safe Lasers [https://www.rp-photonics.com/eye\\_safe\\_lasers.html](https://www.rp-photonics.com/eye_safe_lasers.html)
- (8) Laser Safety [https://en.wikipedia.org/wiki/Laser\\_safety](https://en.wikipedia.org/wiki/Laser_safety)
- (9) Solar Spectrum [https://commons.wikimedia.org/wiki/File:Solar\\_Spectrum.png](https://commons.wikimedia.org/wiki/File:Solar_Spectrum.png)
- (10) Spectral Response <https://www.stemmer-imaging.com/en/knowledge-base/spectral-response/>
- (11) Photodiode Spectrum  
[https://commons.wikimedia.org/wiki/File:Response\\_silicon\\_photodiode.svg](https://commons.wikimedia.org/wiki/File:Response_silicon_photodiode.svg)
- (12) VD-0940C-008M-1C-410 <https://rpmclasers.com/wp-content/uploads/products/VD-0940P-008M-1C-410.pdf>
- (13) 3D Printed Lens and Other Transparent Objects [https://blog.prusa3d.com/3d-printed-lens-and-other-transparent-objects\\_31231/](https://blog.prusa3d.com/3d-printed-lens-and-other-transparent-objects_31231/)
- (14) TSOP986 <https://www.vishay.com/docs/82832/tsop986.pdf>
- (15) C503B-RCN-CW0Z0AA1 <https://assets.cree-led.com/a/ds/h/HB-C503B-RAS-RAN-AAS-AAN-RBS-RBN-ABS-ABN-RCS-RCN-ACS-ACN.pdf>
- (16) SFH 4555 <https://www.digikey.com/en/products/detail/ams-osram-usa-inc/SFH-4555/2205957>
- (17) PixelMan PMD2A Backup Camera  
[https://www.amazon.com/dp/B08NW4MF8V?smid=A2D03PT3N1OAWT&ref\\_=chk\\_typ\\_imgToDp&th=1](https://www.amazon.com/dp/B08NW4MF8V?smid=A2D03PT3N1OAWT&ref_=chk_typ_imgToDp&th=1)

- (18) Padarsey TFT LCD Car Color  
[https://www.amazon.com/dp/B07LGRQRMW/ref=redir\\_mobile\\_desktop?\\_encoding=UTF8&psc=1&ref\\_=yo\\_ii\\_img](https://www.amazon.com/dp/B07LGRQRMW/ref=redir_mobile_desktop?_encoding=UTF8&psc=1&ref_=yo_ii_img)
- (19) MAX98357A <https://www.sparkfun.com/products/14809>
- (20) 28821  
<https://www.mouser.com/ProductDetail/Parallax/28821?qs=qy7CnzY7nG5MydYurKy0xA%3D%3D>
- (21) 28822  
<https://www.mouser.com/ProductDetail/Parallax/28822?qs=qy7CnzY7nG5BAsCj4leAcQ%3D%3D>
- (22) Wi-Fi vs Bluetooth, “<https://www.autodesk.com/products/fusion-360/blog/wifi-vs-bluetooth-wireless-electronics-basics/#:~:text=Bluetooth%20only%20does%20its%20work,2.4GHz%20and%205GHz%20frequencies.”>
- (23) Arduino Mega 2560 Rev 3”<https://store.arduino.cc/products/arduino-mega-2560-rev3>”
- (24) Digi-Key ”[https://media.digikey.com/pdf/Data%20Sheets/Texas%20Instruments%20PDFs/MSP-EXP430G2\\_UG.pdf](https://media.digikey.com/pdf/Data%20Sheets/Texas%20Instruments%20PDFs/MSP-EXP430G2_UG.pdf)”
- (25) Digi-Key “<https://www.digikey.com/en/products/detail/espressif-systems/ESP32-WROOM-32D-N4/9381716>”
- (26) Espressif “[https://www.espressif.com/sites/default/files/documentation/esp32-wroom-32d\\_esp32-wroom-32u\\_datasheet\\_en.pdf](https://www.espressif.com/sites/default/files/documentation/esp32-wroom-32d_esp32-wroom-32u_datasheet_en.pdf)”
- (27) TechTarget  
“<https://www.techtarget.com/iotagenda/definition/microcontroller#:~:text=Memory%20%2D%2D%20A%20microcontroller's%20memory,that%20the%20CPU%20carries%20out>”
- (28) What is a MOSFET: Working and Its application  
“<https://www.elprocus.com/mosfet-as-a-switch-circuit-diagram-free-circuits/>”
- (29) Introduction to Operational Amplifiers  
“<https://www.allaboutcircuits.com/textbook/semiconductors/chpt-8/introduction-operational-amplifiers/>”
- (30) TS972IP Datasheet “<https://www.mouser.com/datasheet/2/389/cd00001508-1795631.pdf>”
- (31) Law Insider, "Technical Standard Definition,"  
<https://www.lawinsider.com/dictionary/technical-standard>

- (32) IPC J STD 001 <https://shop.ipc.org/ipc-j-std-001/ipc-j-std-001-standard-only/Revision-h/english>
- (33) Pcbelec "https://www.pcbelec.com/ipc-standards-for-pcb-manufacturing-and-assembly.html"
- (34) mclpcb "https://www.mclpcb.com/blog/ipc-standards-for-pcbs/"
- (35) Rechargeable Battery Operation "https://power.tenergy.com/rechargeable-battery-operation/"
- (36) Gilshaan Medium document "https://gilshaan.medium.com/react-native-coding-standards-and-best-practices-5b4b5c9f4076"
- (37) "47 CFR Part 15 - RADIO FREQUENCY DEVICES", LII / Legal Information Institute, 2017. <https://www.law.cornell.edu/cfr/text/47/part-15>
- (38) Parallax [https://commons.wikimedia.org/wiki/File:Parallax\\_Example\\_en.svg](https://commons.wikimedia.org/wiki/File:Parallax_Example_en.svg)
- (39) Optics Tutorial <https://highpoweroptics.com/optics-tutorial/>
- (40) Variable Power Optic History <https://www.americanriflemans.org/content/the-variable-power-optic-history-performance/>
- (41) Reflex Sight Diagram  
[https://commons.wikimedia.org/wiki/File:Reflector\\_reflex\\_sight\\_diagram\\_3.png](https://commons.wikimedia.org/wiki/File:Reflector_reflex_sight_diagram_3.png)
- (42) Learning about Electronics  
"http://www.learningaboutelectronics.com/Articles/LED-driver-circuit.php"
- (43) LEDsupply" <https://www.ledsupply.com/blog/understanding-led-drivers/>
- (44) Electronics Hub "https://www.electronicshub.org/ir-illuminator-circuit/"
- (45) How2electronics" <https://how2electronics.com/iot-based-battery-status-monitoring-system-using-esp8266/>
- (46) Flutter for React Native developers "https://docs.flutter.dev/get-started/flutter-for/react-native-devs"
- (47) Autodesk "https://www.autodesk.com/products/eagle/features"
- (48) Altium, "https://www.altium.com/circuitmaker"
- (49) EasyEDA "https://docs.easyeda.com/en/Introduction/Introduction-to-EasyEDA/index.html"
- (50) EasyEDA "https://easyeda.com/page/about"
- (51) 1951 USAF Resolution Test Chart <https://www.edmundoptics.com/knowledge-center/tech-tools/1951-usaf-resolution/>